

NEOLITH

touch.feel.live



SKYLINE

Your technical guide for exterior cladding systems

What is Neolith?
¿Qué es Neolith?

Neolith, a Carbon Neutral Company
Neolith, una compañía Carbon Neutral

Environmental Fact Sheet
Hoja de Datos Ambientales

Certifications and Awards
Certificados y Premios

Formats, applications and thicknesses
Formatos, aplicaciones y espesores

Finishes
Acabados

Strongfix

VM Visible Mechanical

HC Hidden Chemical

HC Slim Hidden Chemical

HC-R Hidden Chemical

HR Hidden Recessed Groove

HU Hidden Undercut

Exclusive models for projects
Modelos solo disponibles para proyectos

Bookmatch & Endmatch

Design variants in 6 mm
Variantes de diseño en 6 mm

General Summary
Resumen General

ABOUT NEOLITH P. 05

TECHNICAL INFORMATION P. 24

PROJECTS P. 60

NEOLITH GALLERY P. 136





NEOLITH
touch.feel.live

Everything we do, say and think at Neolith is centered on the end user. We specialize in finding the essential balance that should always exist between functionality and design, to create unique spaces that help us live better. Because

the best thing about creating something, is living it.

En Neolith, todo lo que hacemos, decimos o pensamos está centrado en el consumidor. Estamos especializados en alcanzar el equilibrio imprescindible que siempre debe existir entre funcionalidad y diseño, para crear espacios únicos que nos ayuden a vivir mejor. Porque

lo mejor de crear algo, es vivirlo.

What is Neolith?

Neolith is a revolutionary and innovative architectural surface with superior technical characteristics made of natural raw materials. It is synonymous to quality, versatility, durability and sustainability as well as class, elegance, style and subtleness.

As a result of innovation efforts to meet its main objectives intrinsically tied to sustainability, Neolith strives to promote new trends in interior design and architecture to satisfy the most demanding needs of both professionals and end consumers.

Neolith inspires unique, functional and sustainable solutions for indoor and outdoor spaces and creates extraordinary experiences through the most cutting-edge surfaces. It is the brand of choice for architects, designers and homeowners and the preferred partner for installers.

¿Qué es Neolith?

Neolith es una superficie arquitectónica revolucionaria e innovadora con características técnicas superiores, fabricada con materias primas naturales. Es sinónimo de calidad, versatilidad, durabilidad y sostenibilidad así como de clase, elegancia, estilo y sutileza.

Como resultado de un esfuerzo de innovación para cumplir sus principales objetivos, intrínsecamente ligados a la sostenibilidad, Neolith tiene como objetivo impulsar las nuevas tendencias del interiorismo y la arquitectura para satisfacer las necesidades más exigentes, tanto de los profesionales como del consumidor final.

Neolith inspira soluciones únicas, funcionales y sostenibles para espacios de interior y exterior y genera experiencias extraordinarias a través de las superficies más innovadoras. Es la marca elegida por arquitectos, diseñadores y propietarios y el socio preferido de los instaladores.

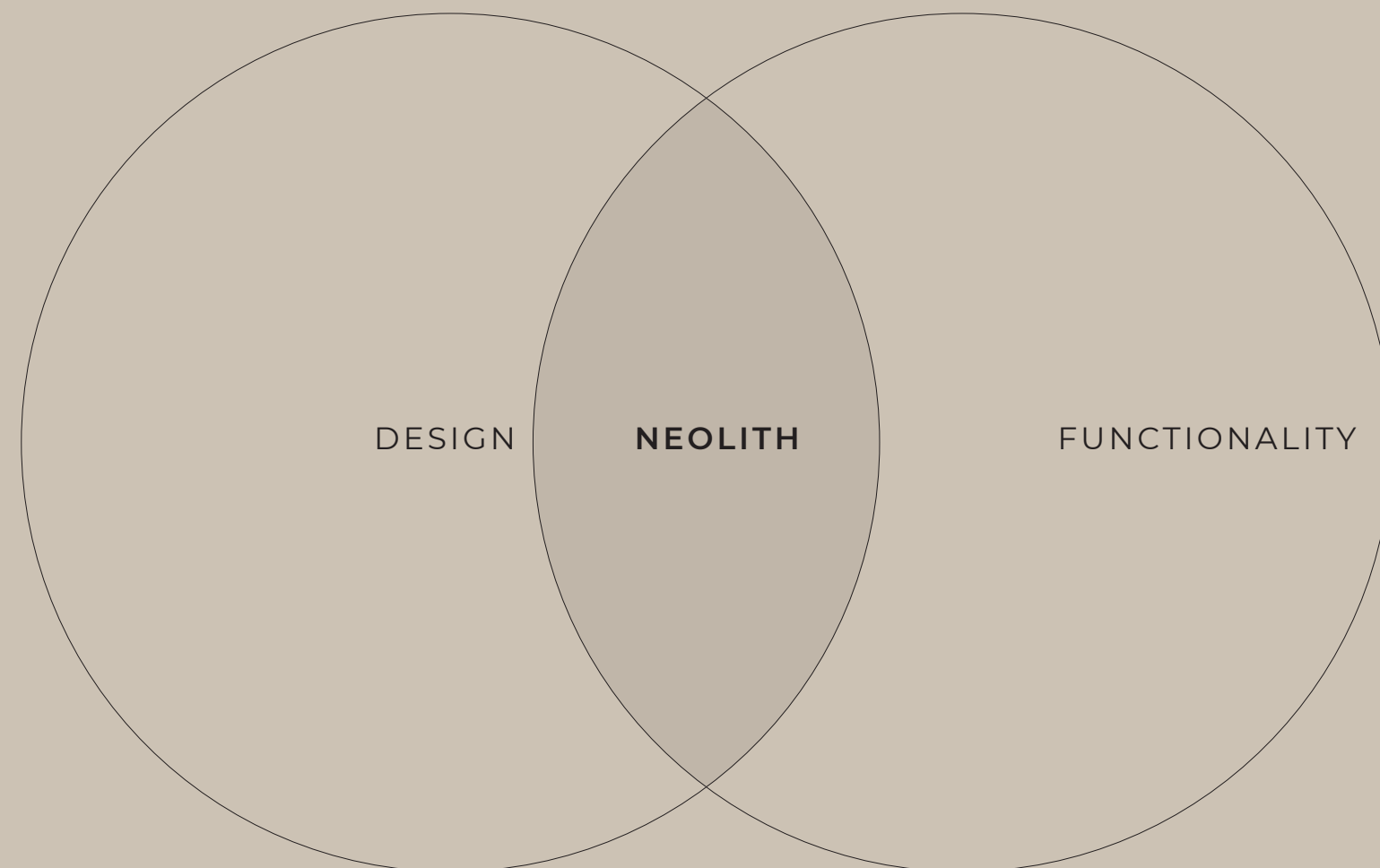



SUSTAINABLE
BEAUTY

THE CONCEPT OF SUSTAINABLE BEAUTY REFLECTS OUR WAY
OF BEING AND CREATING A BETTER FUTURE FOR ALL.

Neolith, towards net-zero emissions

A SOLID PATH TO MINIMIZING ENVIRONMENTAL IMPACT

Since its inception, Neolith's innovation efforts have been intrinsically linked to sustainability, with a firm commitment to achieving decarbonization of its products and achieving a circular economy. Neolith has a strong sustainability policy and has focused on two main axes within its activities: raw materials and energy, in order to minimize environmental impact and create even more sustainable products.

To achieve this, Neolith has taken relevant steps and has had its science-based targets approved by the Science Based Targets initiative (SBTi), which provides target validation services in line with SBTi standards and supports organizations towards their decarbonization journey.

This means Neolith has committed to reach net-zero greenhouse gas emissions across the value chain by 2050. On the other hand, the firm has also committed to reduce absolute scope 1 and 2 GHG emissions 50.4% by 2032 and to reduce absolute scope 3 GHG emissions 30% within the same timeframe, reinforcing the company's dedication to integrating sustainable solutions with exceptional designs that inspire and transform spaces while minimizing environmental impact.

Product life cycle

STRONG COMMITMENT TO CIRCULAR ECONOMY

Neolith surfaces are designed and manufactured from a circular economy perspective to maximize protection and well-being for people and the planet. Neolith is leading the sustainability path to inspire and enable all stakeholders throughout its value chain. The company creates stunning surfaces designed for the best performance and product circularity.

The continuous improvement criteria have enabled relevant awards and certifications such as **Cradle to Cradle Certified® Bronze certification**, breaking away from the traditional model of surface production. It ensures the highest commitment to environmental matters and circularity from cradle to cradle*.



EL CONCEPTO DE SUSTAINABLE BEAUTY REFLEJA NUESTRA FORMA DE SER
Y DE CREAR UN FUTURO MEJOR PARA TODOS.

Neolith, hacia las cero emisiones netas

UN SÓLIDO CAMINO PARA MINIMIZAR EL IMPACTO AMBIENTAL

Desde sus inicios, los esfuerzos de innovación de Neolith han estado intrínsecamente ligados a la sostenibilidad, con un firme compromiso para lograr la descarbonización de sus productos y avanzar hacia una economía circular. Neolith cuenta con una sólida política de sostenibilidad y ha centrado sus actividades en dos ejes principales: materias primas y energía, con el objetivo de minimizar el impacto ambiental y crear productos aún más sostenibles.

Para lograrlo, Neolith ha dado pasos significativos y ha obtenido la aprobación de sus objetivos basados en la ciencia por parte de la iniciativa Science Based Targets (SBTi), que proporciona servicios de validación de objetivos alineados con sus estándares y apoya a las organizaciones en su camino hacia la descarbonización.

Esto significa que Neolith se ha comprometido a alcanzar cero emisiones netas de gases de efecto invernadero (GEI) en toda su cadena de valor para 2050. Además, la empresa ha asumido el compromiso de reducir en un 50,4% sus emisiones absolutas de GEI en los alcances 1 y 2 para 2032, y en un 30% las emisiones absolutas de alcance 3 en el mismo periodo. Todo ello refuerza la dedicación de la compañía a integrar soluciones sostenibles con diseños excepcionales que inspiran y transforman los espacios, minimizando su impacto en el entorno.

Ciclo de vida del producto

FIRME COMPROMISO CON LA ECONOMÍA CIRCULAR

Las superficies Neolith se diseñan y fabrican desde una perspectiva de economía circular para maximizar la protección y el bienestar de las personas y el planeta. Neolith lidera el camino de la sostenibilidad para inspirar y capacitar a todas las partes interesadas a lo largo de su cadena de valor. La empresa crea superficies asombrosas diseñadas para obtener el mejor rendimiento y circularidad del producto.

Los criterios de mejora continua han permitido obtener prestigiosos premios y certificaciones, como la certificación **Cradle to Cradle Certified® Bronze**, desmarcándose del modelo tradicional de producción de superficies. Esto garantiza el máximo compromiso con las cuestiones medioambientales y la circularidad de la cuna a la cuna.

Environmental care

Neolith takes a holistic approach to environmental impacts throughout the product life cycle by ensuring responsible management at every stage of the production process. Priority is given to minimizing waste, reducing pollution, preserving natural resources and promoting energy efficiency.

TOWARDS NET-ZERO

In 2019, Neolith became the first company in its industry to achieve carbon neutrality. By calculating its full carbon footprint across its main scopes, **the organization is committed to reducing emissions and aims to achieve net-zero by 2050.**

ZERO WASTE

Neolith has achieved the Zero Waste certification, which acknowledges that **the company recycles over 96% of its industrial waste.**

REUSE OF INDUSTRIAL WATER

Neolith recycles **the entirety** of the industrial water used in its production processes.

RENEWABLE ENERGIES

100% of the electricity used in Neolith's production process is sourced either from **self-generated energy produced at Neolith's solar plant or from certified renewable energy sources.**

UNGC

Neolith is a signatory of the **United Nations Global Compact (UNGC)**, reinforcing its commitment to the initiative's climate action principles.

ECOVADIS GOLD

EcoVadis, the world's most reputable sustainability index, **ranks Neolith in the 98th percentile**, confirming its excellence in corporate policies and sustainable practices.

CRADLE TO CRADLE

Neolith has obtained the **Cradle to Cradle Certified® Bronze** certification, the world's leading standard for safe, circular and responsible materials and products.

SBTI

In 2024, **the SBTi validated Neolith's net-zero science-based targets**, reaffirming the brand's commitment to reducing emissions and combating climate change by 2050.

Cuidado del medioambiente

Neolith adopta un enfoque integral para reducir su impacto ambiental a lo largo del ciclo de vida del producto, asegurando una gestión responsable en cada etapa del proceso productivo. Su prioridad es minimizar los residuos, reducir la contaminación, preservar los recursos naturales y fomentar la eficiencia energética.

HACIA LAS CERO EMISIONES NETAS

En 2019, Neolith se convirtió en la primera empresa de su sector en lograr la neutralidad en carbono. Al calcular su huella de carbono para sus principales alcances, **la compañía se compromete a reducir sus emisiones y aspira a alcanzar cero emisiones netas de gases de efecto invernadero para 2050.**

RESIDUO CERO

Neolith ha obtenido la certificación Zero Waste, que reconoce que **la empresa recicla más del 96% de sus residuos industriales.**

REUTILIZACIÓN DEL AGUA INDUSTRIAL

Neolith reutiliza **el 100%** del agua industrial utilizada en sus procesos de producción.

ENERGÍAS RENOVABLES

El 100% de la energía eléctrica utilizada durante el proceso productivo de Neolith proviene de **energía generada en su planta solar o de fuentes con garantía de origen renovable.**

UNGC

Neolith es signatario del **Pacto Mundial de las Naciones Unidas (UNGC)**, reforzando su compromiso con los principios de acción climática de la iniciativa.

ECOVADIS GOLD

EcoVadis, el índice de sostenibilidad más prestigioso a nivel mundial, **sitúa a Neolith en el percentil 98**, confirmando su excelencia en políticas corporativas y prácticas sostenibles.

CRADLE TO CRADLE

Neolith ha obtenido la certificación **Cradle to Cradle Certified® Bronze**, el estándar global más exigente para materiales y productos seguros, circulares y responsables.

SBTI

En 2024, **la iniciativa SBTi validó los objetivos basados en la ciencia para la reducción de emisiones de Neolith**, reafirmando el compromiso de la marca en la lucha contra el cambio climático y la reducción de emisiones para 2050.

Product composition

Neolith is an innovative surface with a unique sustainability profile. Design, durability and superior technical properties are combined to create kitchen and bathroom countertops, wall and floor cladding, facades and exclusive furniture.

NATURAL COMPOSITION

Neolith uses the best raw materials: a selection of premium all-natural minerals. Neolith does not add plastics or resins to its composition.

RECYCLABLE

Due to the all-natural composition, Neolith products have an extended lifecycle and can be recycled at the end of their useful life.

98R

Neolith incorporates up to 98% recycled materials in some of its models, while maintaining its superior technical and aesthetic properties.

NO ADDED QUARTZ

Neolith does not add crystalline silica to its composition. Its presence in the product is only detected in the form of impurities and is always below 9%, positioning it in the lowest crystalline silica content range in the market*.

* See product technical data sheet

ADDITIONAL SUSTAINABLE BENEFITS

Neolith's unique sintering process provides additional sustainable benefits.

Refurbishment

Neolith can be applied directly to existing surfaces. This saves time, costs and generates less waste to be transported and treated, thereby further reducing net CO₂ emissions.

Optimized energy consumption

Neolith's high resistance to extreme temperatures makes it the ideal material of choice for ventilated facades. The thermal insulation and ventilation between the Neolith facade and the building itself optimizes the building's energy consumption.

25-year warranty

Neolith countertops and slabs do not require frequent replacement or maintenance treatments. That is why Neolith offers a 25-year warranty on its countertops for residential use, subject to registration and according to the terms and conditions outlined in neolith.com/en/warranty

Composición del producto

Neolith es una superficie innovadora con un perfil de sostenibilidad único. Diseño, durabilidad y propiedades técnicas superiores se combinan para crear encimeras de cocina y baño, revestimientos de paredes y suelos, fachadas y mobiliario exclusivo.

COMPOSICIÓN NATURAL

Neolith utiliza las mejores materias primas: una selección de minerales naturales de alta calidad. Neolith no añade plásticos ni resinas en su composición.

98R

Neolith incorpora hasta un 98% de contenido reciclado en algunos de sus modelos, conservando sus propiedades técnicas y estéticas superiores.

RECICLABLE

Debido a su composición natural, Neolith prolonga su ciclo de uso y puede ser reciclado al final de su vida útil.

SIN CUARZO AÑADIDO

Neolith no añade sílice cristalina en su composición. Su presencia en el producto solo se detecta en forma de impurezas y siempre en niveles inferiores al 9%, posicionándose como la superficie con el rango de contenido en sílice cristalina más bajo del mercado*.

* Consultar ficha técnica de producto

BENEFICIOS SOSTENIBLES ADICIONALES

El proceso de sinterización único de Neolith proporciona beneficios adicionales.

Rehabilitación

Neolith se puede aplicar directamente sobre superficies existentes. De este modo, se ahorra tiempo, costes y se generan menos residuos que deban transportarse y tratarse, reduciendo aún más las emisiones netas de CO₂.

Consumo de energía optimizada

La alta resistencia de Neolith a temperaturas extremas hace que sea ideal para fachadas ventiladas. El aislamiento térmico y ventilación entre la fachada Neolith y el propio edificio optimiza el consumo de energía.

25 años de garantía

Las encimeras y tablas Neolith no necesitan tratamientos de sustitución o mantenimiento frecuentes. Por eso Neolith ofrece una garantía de hasta 25 años en sus encimeras de cocina para uso residencial, previo registro y de acuerdo con los términos y condiciones descritos en neolith.com/es/garantia

Certifications and Awards

Certificados y premios

Since its inception in 2009, Neolith has received recognition through more than 50 international design and architecture awards for its forward-thinking, innovative approach and the high quality of its products and processes.

These accolades reflect Neolith's pioneering spirit as a company constantly evolving to meet the needs and expectations of its current and future customers.

Desde su fundación en 2009, Neolith ha recibido el reconocimiento a través de más de 50 premios internacionales de diseño y arquitectura por su enfoque innovador y vanguardista y la alta calidad de sus productos y procesos.

Estos galardones reflejan el espíritu pionero de Neolith, una compañía en constante evolución para satisfacer las necesidades y expectativas de sus clientes actuales y futuros.

CERTIFICATIONS / CERTIFICADOS



Designed and produced by TheSize Surfaces in Spain



European Commission Certification



China Compulsory Certificate



ISO 9001:2015



ISO 14001:2015



NSF Certifies that Neolith is totally suitable for contact with food



Registration, Evaluation, Authorisation and Restriction of Chemicals



OK Kosher Certification



ICC-ES Certification for the Strongfix System for ventilated facades



The International EPD System



Health Product Declaration



Greenguard Certification



Member of the US Green Building Council (USGBC)



Ecological labels and environmental declarations



The Declare Label



M1 Classification for low-emitting building materials



Friendly Materials



UN Global Compact



Zero Waste



Ecovadis Gold 2024



* Cradle to Cradle Certified®



Byggarbedömningen



SundaHus



NFPA-285



FL 28783.1



ETA 22/0800



ASTM E84



ASTM E136



Saudi Quality Mark

PRODUCT DESIGN AWARDS / PREMIOS DE DISEÑO DE PRODUCTO



German Design Award 2025, 2019



Surface Design Awards 2025



Future Icons 2025 Awards by Country & Town House



Great Design AD 2024, 2017



Designerati Awards 2024



KBB Product Awards 2024



Archiproducts Awards 2024



1ª Mención del Premio al Mejor Proyecto de Casa Decor 2024



Segundo Premio al Mejor Proyecto (Casa Yin) y premio INSIDE al espacio más votado entre expositores 2024



Premio Diseño de Interiores al mejor stand - Cevisama 2023



Primer Premio al Mejor Producto (mesa Neo_Hall) - Marbella Design & Art 2023



Alfa De Oro 2023, 2013



Best Company of the Year Award 2022 El Periódico Mediterráneo



Best Of KBIS 2023



X AWARDS CASA DECOR 2022



Best Booth Honorable Mention KBIS 2022



Architectural Record 2021



Global Kitchen Design



Idea Awards 2019



Plus X Award



Red Dot Award 2019, 2017, 2015



Interior Design Best of the Year 2018, 2017



A'Design Award 2018, 2016



Product Innovation Awards 2018, 2016



Premio Interiores 2017



Interzum Award



KBB Readers Choice Award 2017, 2016



D Award 2017



Architectural Record Award 2016



A+Award Architizer 2016



IDC Innovation Awards



KB Culture Awards 2016



Best of Houzz 2016



30 More Innovative Products



Producto del año en Innovación y Tecnología



AP50 Readers Choice



Plus X Award



Muuz Awards



KBB Readers Choice Awards 2015



PIA Awards 2015, 2014

SUSTAINABILITY AND INSTALLATION AWARDS / PREMIOS DE SOSTENIBILIDAD E INSTALACIÓN



Edison Awards Gold



Materialica Gold Award



Money-Saving Products Winner



Architectural Contest 2017



Installation Award

* The Cradle to Cradle Certified® Bronze certification recognizes that most Neolith products meet this global standard. The complete list can be consulted officially on the Cradle to Cradle Products Innovation Institute website.

Technical Features

Características Técnicas



NEAR ZERO POROSITY / POROSIDAD CERCANA A CERO

Waterproof and resistant to liquids, with an absorption level of almost zero.
Impermeable y resistente a líquidos, con un nivel de absorción próximo a cero.



SCRATCH RESISTANT * / RESISTENTE AL RAYADO*

Its hard surface makes it resistant to scratches and abrasion.
Resistente al rayado y a la abrasión gracias a la dureza de su superficie.



RESISTANT TO HIGH TEMPERATURES / RESISTENTE A LAS ALTAS TEMPERATURAS

It does not burn in contact with fire nor does it emit smoke or toxic substances when subjected to high temperatures in daily use.
No se quema en contacto con el fuego ni emite humo ni sustancias tóxicas al ser sometido a altas temperaturas en su uso cotidiano.



GRAFFITI PROOF

Neolith's low porosity makes it very easy to clean and maintenance free even for outdoor applications.
La baja porosidad de Neolith hacen que sea muy fácil de limpiar.



FREEZE-THAW PROOF

Neolith panels are engineered to withstand freeze-thaw cycles, ensuring durability and resistance to cracking under fluctuating temperatures while exceeding the performance requirements of ASTM C1026.

Los paneles de Neolith soportan cambios drásticos de temperatura, garantizando la durabilidad y resistencia a la rotura bajo altas fluctuaciones en la temperatura ambiente, cumpliendo y superando los requisitos marcados en el ASTM C1026.

* PLEASE CHECK USE DATASHEET AT NEOLITH.COM

* CONSULTAR LA FICHA DE USO EN NEOLITH.COM



ULTRA-HYGIENIC / ULTRAHIGIÉNICO

Neolith's special composition makes it resistant to most chemical products and it can be disinfected with a wide range of strong household cleaning products.

La composición especial de Neolith, lo hace impermeable a la mayoría de los productos químicos, pudiendo ser desinfectado con una amplia gama de potentes productos limpiadores domésticos.



LIGHTWEIGHT / LIGERO

Lighter than many exterior cladding materials, Neolith is available in a variety of thicknesses for facades: 6 mm (1/4") - 12 mm (1/2").

Más ligero que muchos revestimientos o superficies exteriores, Neolith se puede adquirir en diversos espesores para fachadas: 6 mm (1/4") - 12 mm (1/2").



UV RESISTANCE / RESISTENTE A RAYOS UV

Being 100% natural, its colors do not fade away when exposed to sunlight or other extreme weather conditions.

Siendo 100% natural, los colores no se desvirtúan cuando el material se expone al sol o a condiciones meteorológicas extremas.



RESISTANT TO BENDING / RESISTENTE A LA FLEXIÓN

Its high modulus of rupture makes it resistant to high pressure and heavy loads.

Módulo de rotura elevado. Resistente a altas cargas de presión y peso.

Formats, Applications and Thicknesses

Formatos, aplicaciones y espesores

Neolith is manufactured in large format slabs of around 5 m² - 54ft². This allows the product to adapt to any type of project, reducing joints, making it easier to clean and improving its look. Also, it is quicker to install.

Neolith se fabrica en losas de gran formato de unos 5 m². Esto permite que el producto se adapte a cualquier tipo de proyecto, reduciendo las juntas, aumentando la facilidad de limpieza del producto y mejorando su estética. Además, la instalación es más rápida.

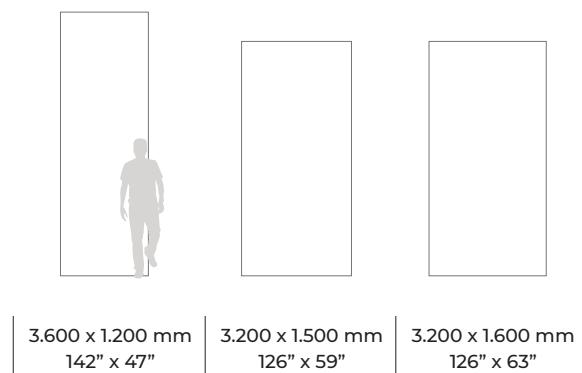

Interior walls Revestimiento interior	3+	6 · 6+	12 · 12+
Interior floors Pavimento interior		6 · 6+	12 · 12+
Bonded Facade Fachada aplacada exterior	3+	6 · 6+	12 · 12+
Exterior floors Pavimento exterior		6 · 6+	12 · 20
Ventilated façade with exposed fixing system Fachada ventilada anclaje visto		6+	12+
Ventilated façade with hidden fixing system Fachada ventilada anclaje oculto		6+	12+
Countertops Encimeras			12 · 20
Heavy traffic floors Pavimento alto tránsito		6+	12 · 20
Interior cladding over existing walls Revestimiento interior sobre material	3+	6 · 6+	
Interior flooring over existing floors Pavimento interior sobre material		6 · 6+	
Furniture Mobiliario	3 · 3+	6 · 6+	12 · 20

● Recommended thicknesses
Espesores recomendados

Cut to size formats also available for projects.
Dimensions in inches are Nominal inches.

Formatos de corte a medida también para proyectos.

+ Slab reinforced with fiberglass.

+ Tabla reforzada con fibra de vidrio.

Neolith offers premium surfaces in four different thicknesses.
Neolith ofrece superficies premium en cuatro espesores diferentes.

Each one a specific range of applications: / Cada uno tiene su propia gama específica de aplicaciones:

3 MM 1/8"	INTERIOR WALL CLADDING, FURNITURE CLADDING REVESTIMIENTOS MUROS INTERIORES, PANELADO DE MUEBLES	6 MM 1/4"	INDOOR / OUTDOOR FLOORING, INTERIOR AND EXTERIOR CLADDING, FURNITURE CLADDING PAVIMENTOS INT./EXT., REVESTIMIENTOS INTERIORES Y EXTERIORES, PANELADO DE MOBILIARIO
12 MM 1/2"	KITCHEN COUNTERTOPS, TABLE TOPS AND BATHROOM VANITIES ENCIMERAS DE COCINA, MESAS Y TOCADORES DE BAÑO	20 MM 3/4"	KITCHEN COUNTERTOPS AND TABLE TOPS ENCIMERAS DE COCINA Y MESAS

STANDARD TILE FORMATS / FORMATOS DE BALDOSAS

Neolith offers premium sintered stone surfaces in standard tile formats.

Neolith ofrece superficies de piedra sinterizada Premium en los formatos estándar de baldosa.

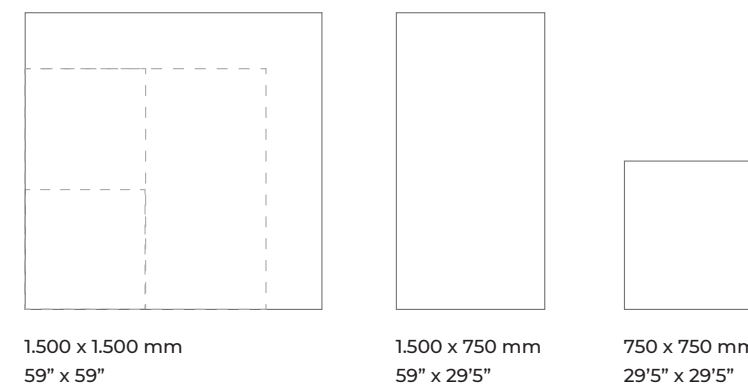

1.500 x 1.500 mm
59" x 59"

1.500 x 750 mm
59" x 29.5"

750 x 750 mm
29.5" x 29.5"

Cut-to-size formats also available for projects.
Dimensions in inches are Nominal inches.

Formatos de corte a medida también para proyectos.

1.200 x 1.200 mm
48" x 48"

1.200 x 600 mm
48" x 24"

600 x 600 mm
24" x 24"

Possibility of adapting the following sizes from
the standard tile.

Posibilidad de adaptar los siguientes tamaños
a partir de la baldosa estándar.

Finishes / Acabados

Neolith is available in different finishes that add richness and value to the designs created with these surfaces: from rough textures with relief to shiny polishes with linear reflections.

Most common finishes for ventilated facade applications.

Neolith está disponible en distintos acabados que aportan riqueza y valor a los diseños creados con estas superficies: desde texturas rugosas con relieve hasta brillantes pulidos con reflejos lineales.

Acabados más comunes para aplicaciones de fachadas ventiladas

A complete range to stimulate the sight and touch.

Todo un repertorio para estimular la vista y el tacto.

MATTE FINISHES / ACABADOS MATE

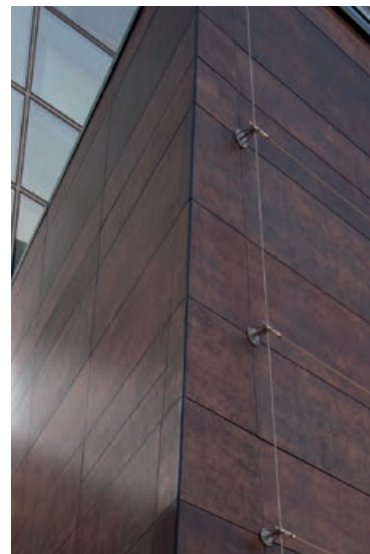

SATIN

A completely matte finish. Highly resistant and ideal for commercial applications.

Acabado completamente mate. Altamente resistente e ideal para aplicaciones comerciales.



SILK

A matte finish with a thin layer of glaze that provides a subtle shine and a nice soft touch. This finish is extremely easy to clean.

Acabado mate con una ligera capa de esmalte que aporta un brillo sutil y una agradable suavidad al tacto. Acabado superficial que resulta extremadamente fácil de limpiar.



ULTRASOFT

Matte texture with the highest softness and depth

Textura mate con el máximo grado de suavidad y profundidad.

TEXTURED FINISHES / ACABADOS CON TEXTURAS

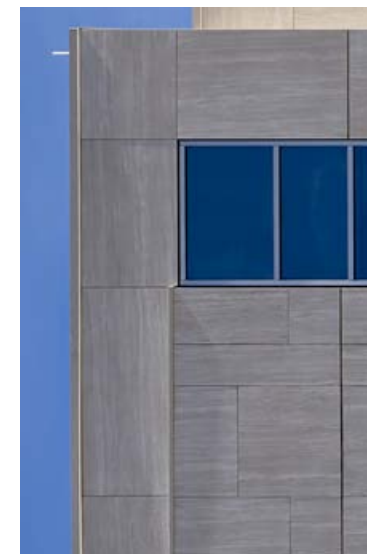

RIVERWASHED

A finish with a rough texture and high relief for surfaces that evoke sensations to the touch.

Acabado con textura rugosa y alto relieve para superficies que evocan sensaciones al tacto.



SLATE FINISH

Similar to a natural slate, the Slate finish creates the illusion of strata on the surface.

Como una pizarra natural, el acabado Slate crea la ilusión de estratos en la superficie.



NATURAL TOUCH

This texture enhances the natural beauty of each piece, perfectly matching design and digital texture.

Esta textura realza la belleza natural de cada pieza, combinando a la perfección el diseño y la textura digital.

GLOSSY FINISHES / ACABADOS BRILLO



DÉCOR POLISHED

The Décor Polished gives a perfectly linear reflection to the colors of the Classtone Collection, which gains in depth and elegance.

Décor Polished confiere un reflejo perfectamente lineal a los colores de la Colección Classtone, que gana en profundidad y elegancia.

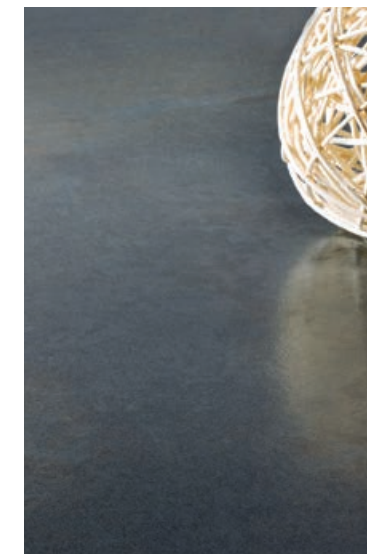

STEEL TOUCH

Steel Touch is Neolith's metallic finish with smooth reflections and surfaces.

El acabado Steel Touch es un enfoque metálico que ofrece Neolith con unos reflejos suaves y superficies

Cleaning and Maintenance

Limpieza y Mantenimiento

POLISHED AND ULTRASOFT FINISHES

Neolith Polished and Ultrasoft finishes stand out for their esthetic features. To achieve such degree of gloss and texture, the finest raw materials and the most cutting-edge technology have been used in their production. Unlike the other Neolith matte finishes (Satin, Riverwashed, Silk and Slate), special care must be taken when using certain chemical products on the countertop or regarding its resistance to scratches.

ACABADOS PULIDOS Y ULTRASOFT

Las superficies Neolith acabado Pulido y Ultrasoft destacan por sus características estéticas. Para lograr este nivel de brillo y textura, se han utilizado en su producción las materias primas de mayor calidad y la tecnología más avanzada. Al contrario que con los otros acabados mate Neolith (Satin, Silk, Riverwashed y Slate), hay que tener en cuenta consideraciones especiales a la hora de usar algunos productos químicos sobre la encimera o acerca de su resistencia al rayado.

SATIN, SILK, RIVERWASHED AND SLATE FINISHES / ACABADOS

Neolith surfaces are easy to clean since debris and residues cannot penetrate the material, thus guaranteeing good hygiene. In most cases, only a damp cloth is needed for cleaning. Stains created by food or other substances of general use are easy to remove. Even highly aggressive domestic cleaning agents do not affect the Neolith surface. Here are some of the substances recommended for removing stains:

Las superficies Neolith tienen una limpieza fácil, ya que los residuos que se depositen, no pueden penetrar en el material, por lo que garantizan una buena higiene. Para la mayoría de los casos, sólo bastará con un paño húmedo para limpiarla. Las manchas producidas por alimentos u otras sustancias de uso general son fáciles de eliminar. Incluso los productos de limpieza domésticos altamente agresivos no afectan a la superficie de Neolith. Estas son algunas de las sustancias recomendadas para eliminar las manchas:

CLEANING PRODUCTS	
SUITABLE	NOT SUITABLE
Degreasers	Cleaners and abrasive sponges
Ammonia	Bleach
Solvents	Ferrokitt
Alcohol	Hydrofluoric acid
Acetone	Scrub cleaning creams
-	Alkalis (potash, soda)

PRODUCTOS DE LIMPIEZA	
APTO	NO APTO
Desengrasantes	Limpiadores y esponjas abrasivas
Amoniaco	Lejía
Disolventes	Ferrokitt
Alcohol	Ácido hidrófluórico
Acetona	Limpiadores de vitrocerámica
-	Alcalinos (potasa, sosa)

APPLICATIONS FOR NEOLITH SATIN, SILK, RIVERWASHED AND SLATE FINISHES		
TYPES OF STAINS / TIPOS DE MANCHAS	CHEMICAL PRODUCT / PRODUCTO QUÍMICO	COMMON EXAMPLES / EJEMPLOS COMUNES
Grease / Grasas	Alkaline - Solvent / Alcalino - Solvente	Detergent / Detergente
Oil / Aceite	Solvent / Solvente	Ammonia / Amoniaco
Ink / Tinta	Oxidant - Solvent / Oxidante - Solvente	Alcohol or acetone / Alcohol o acetona
Rust / Óxido, herrumbre	Acid / Ácido	Hydrochloric acid and descaling products / Sulfumán y desincrustantes
Lime / Cal	Acid / Ácido - Antical / Antical	Descaling products / Desincrustantes
Cement / Cemento	Acid / Ácido	Hydrochloric acid, oxygenated water and descaling products / Sulfumán, agua oxigenada y desincrustantes
Wine / Vino	Alkaline / Alcalino	Ammonia or bleach / Amoniaco o lejía
Coffee / Café	Alkaline - Solvent / Alcalino - Solvente	Ammonia or bleach / Amoniaco o lejía
Plaster / Yeso	Acid / Ácido	Hydrochloric acid and descaling products / Sulfumán y desincrustantes
Candle wax / Cera de velas	Solvent / Solvente	Alcohol or acetone / Alcohol o acetona
Iodine / Yodo	Oxidant / Oxidante	Bleach / Lejía
Blood / Sangre	Oxidant / Oxidante	Bleach, oxygenated water / Lejía, agua oxigenada
Ice cream / Helado	Alkaline / Alcalino	Detergent / Detergente
Resins / Resinas	Solvent / Solvente	Alcohol or acetone / Alcohol o acetona
Fruit juice / Jugo de frutas	Oxidant / Oxidante	Bleach / Lejía
Aluminum scratches / Viruta de aluminio	Acid / Ácido	Hydrochloric acid and descaling products / Sulfumán y desincrustantes

NEOLITH POLISHED FINISH APPLICATIONS	
SUITABLE	NOT SUITABLE
Countertop	Outdoor flooring (abrasion by dust)
Interior and exterior cladding	Interior flooring with medium or high traffic (slippery, abrasion by transit) Bathroom and wet areas flooring
Interior flooring with exclusively pedestrian traffic of low intensity, not connected to the outside	Sinks (impacts, chafing)

APLICACIONES DE NEOLITH ACABADO PULIDO	
APTO	NO APTO
Encimera	Pavimento exterior (Abrasión por polvo)
Revestimiento interior, exterior	Pavimento interior con tránsito medio o alto. (Resbaladizo, abrasión por tránsito) Pavimento de baños y zonas húmedas
Pavimento interior de una vivienda con tránsito exclusivamente peatonal de intensidad baja, no comunicado con el exterior	Fregaderos (Impactos, Rozaduras)

If you can imagine it, our technology can bring it to life
Tú lo imaginas y nuestra tecnología lo hace realidad

TECHNICAL INFORMATION

The first impression of a building is its façade, and Neolith's façade panels are crafted to impress and satisfy even the most discerning architects. With outstanding performance, technical features, and large formats, Neolith enables the creation of innovative designs and shapes that captivate and meet the unique needs of each project. This versatility, combined with Neolith's exceptional qualities - such as sustainability and durability - ensures that buildings not only come to life but remain timeless for generations to come.

La primera impresión de un edificio es su exterior y los paneles de fachada Neolith están diseñados para convencer incluso a los arquitectos más exigentes. Sus extraordinarias prestaciones, características técnicas y grandes formatos permiten crear diseños y formas innovadoras que sorprenden y responden a las necesidades de cada proyecto. Esta versatilidad, combinada con las magníficas cualidades de Neolith, como la sostenibilidad y resistencia, hacen que los edificios cobren vida y puedan disfrutarse hoy y siempre.



Attachment systems / Sistemas de fijación

STRONGFIX

Dual attachment system
Concealed fasteners
6mm+ & 12mm+

Adjustable build-up
ICC & NFPA-285 certified

Sistema de fijación mixta
Fijación oculta
6mm+ y 12mm+

Salida del sistema ajustable
Certificado ICC & NFPA-285

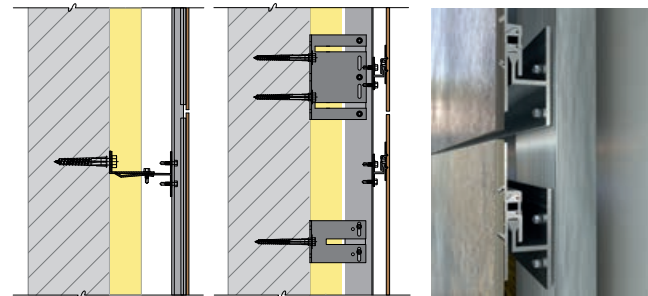

HC-R HIDDEN CHEMICAL

Chemical attachment system
+ reinforcing clip
Concealed fasteners
6mm+

Adjustable build-up

Sistema de fijación química
+ clip de refuerzo
Fijación oculta
6mm+

Salida del sistema ajustable

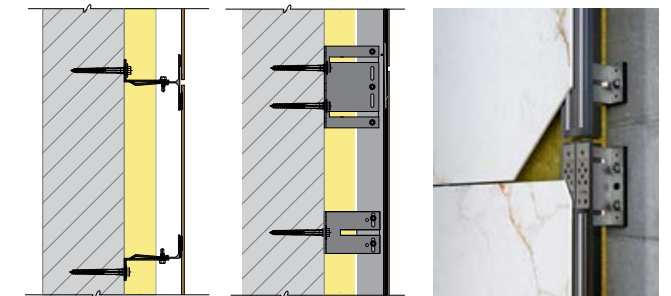

VM VISIBLE MECHANICAL

Dual attachment system
Exposed fasteners
6mm+

Adjustable build-up

Sistema de fijación mixta
Fijación vista
6mm+

Salida del sistema ajustable

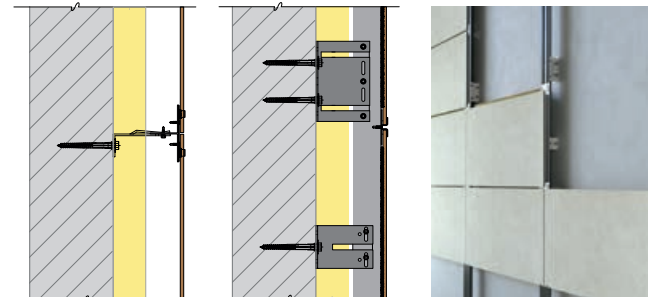

HR HIDDEN RECESSED GROOVE

Mechanical attachment system
Concealed fasteners
12mm+ & 20mm

Adjustable build-up
ETA certified

Sistema de fijación mecánica
Fijación oculta
12mm+ y 20mm

Salida del sistema ajustable
Certificado ETA

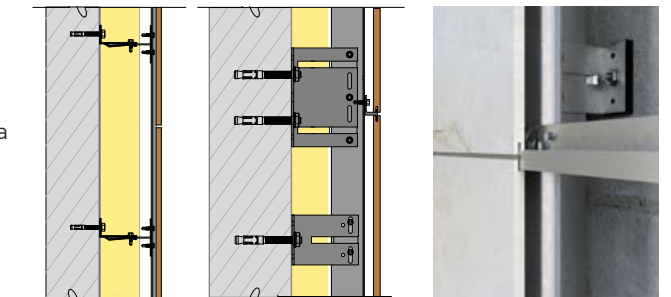

HC HIDDEN CHEMICAL

Chemical attachment system
Concealed fasteners
6mm+

Adjustable build-up

Sistema de fijación química
Fijación oculta
6mm+

Salida del sistema ajustable

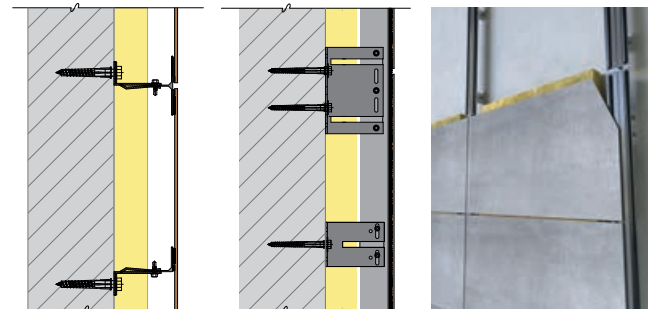

HU HIDDEN UNDERCUT

Mechanical attachment system
Concealed fasteners
12mm+ & 20mm

Adjustable build-up
ETA certified

Sistema de fijación mecánica
Fijación oculta
12mm+ y 20mm

Salida del sistema ajustable
Certificado ETA

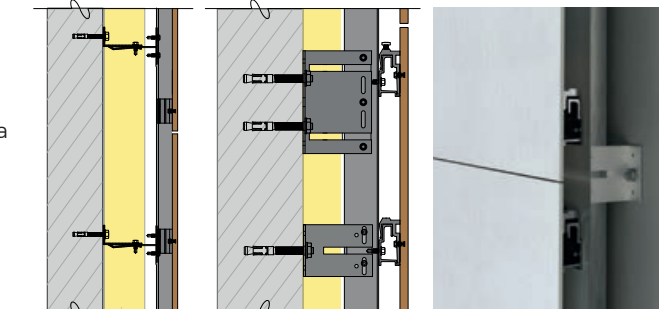

HC SLIM HIDDEN CHEMICAL

Chemical attachment system
Concealed fasteners
6mm+

Non-adjustable build-up

Sistema de fijación química
Fijación oculta
6mm+

Salida del sistema no ajustable

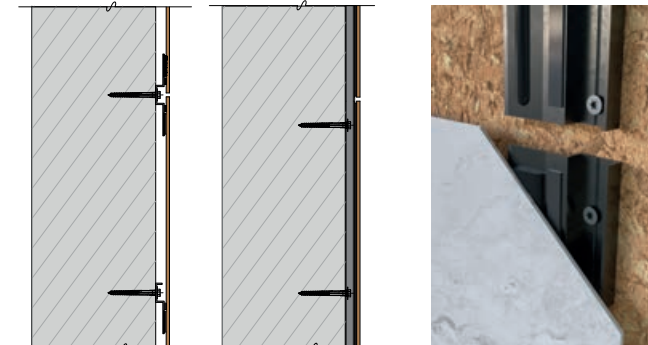

Advantages of Ventilated Facades Ventajas de las fachadas ventiladas

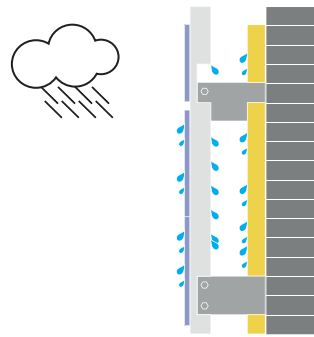

MOISTURE MANAGEMENT / CONTROL DE LA HUMEDAD

The airflow in the cavity between the NEOLITH outer layer and the building substrate enables the passive removal of water and water vapor, helping to prevent condensation, mold growth and material rot.

La circulación de aire en la cámara entre la capa externa de paneles NEOLITH y el muro estructural permite la salida de agua y vapor de agua, evitando la condensación, generación de moho y deterioro de los materiales.

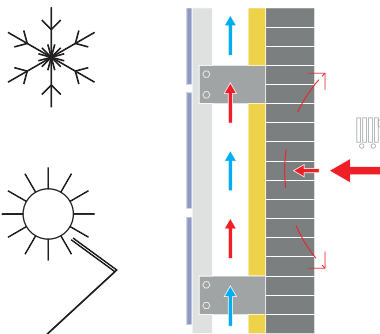

THERMAL INSULATION / AISLAMIENTO TÉRMICO

Continuous insulation located in the air cavity improves the building's energy efficiency and eliminates thermal bridges, minimizing temperature variations and reducing energy consumption during both hot and cold seasons.

La inclusión de aislamiento térmico continuo en la cámara de aire mejora la eficiencia energética del edificio y elimina los puentes térmicos, minimizando las fluctuaciones de temperatura y reduciendo el consumo de energía tanto en estaciones calurosas como frías.

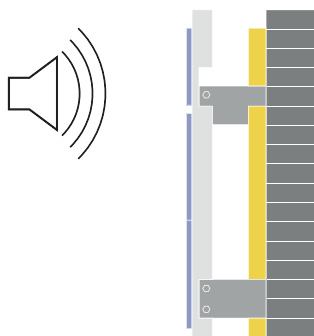

ENHANCED ACOUSTIC PERFORMANCE / MEJORA DEL AISLAMIENTO ACÚSTICO

Rainscreen systems contribute to improved sound insulation by adding an extra barrier that absorbs external noise, enhancing the building's acoustic comfort.

Las fachadas ventiladas contribuyen a mejorar el aislamiento acústico al agregar una barrera adicional que absorbe el ruido exterior, mejorando el confort acústico del edificio

Self-Cleaning and Sustainable Facades Fachadas autolimpiables y sostenibles

Neolith offers on demand an aqueous and titanium dioxide nanoparticle-based treatment that is sprayed on Neolith to create a photo-catalytic, self-cleaning and decontaminating effect.

HOW DOES IT WORK?

The technology creates self-cleaning surfaces that purify the air by means of two fundamental processes: PHOTOCATALYSIS and SUPERHYDROPHILICITY.

Over time, building Facades become dirty and full of contaminating agents that are carried through the air to the surface. When the surface enters into contact with sunlight (or some LED lights), titanium dioxide particles are activated, which use light energy to transform the moisture in the air into oxidizing agents which destroy the nitrogen dioxide particles and contaminating agents and transform them into water vapor and salt.

This process, which is known as PHOTOCATALYSIS, is repeated millions of times per second until all contaminants are destroyed, meaning that the surface is constantly being self-cleaned.

SUPERHYDROPHILICITY is produced to complete the treatment action. Thanks to the properties of Neolith Facades, water expands on the surface evenly when it rains to drag and remove any remaining dirt particles. This leaves the surface completely clean without any water marks.

Neolith ofrece sobre pedido un tratamiento de base acuosa y nanopartículas de dióxido de titanio que se rocía sobre el material para crear un efecto fotocatalítico, autolimpiante y descontaminante.

¿CÓMO SE PRODUCE?

La tecnología crea superficies autolimpiantes que purifican el aire mediante dos procesos fundamentales: FOTOCATÁLISIS y SUPERHIDROFILIA.

Las fachadas de los edificios, con el paso del tiempo se van ensuciando y llenando de agentes contaminantes llevados por el aire hasta la superficie. Cuando la superficie entra en contacto con la luz solar (o algunas luces LED) se activan las partículas de dióxido de titanio, que utilizan la energía lumínica para transformar la humedad del aire en agentes oxidantes, que destruyen las partículas de dióxido de nitrógeno y agentes contaminantes y las transforman en vapor de agua y sal.

Este proceso llamado FOTOCATÁLISIS, se repite millones de veces por segundo, hasta que todos los contaminantes se destruyen, por lo que la superficie se está autolimpiando continuamente.

Para completar la acción del tratamiento se produce la SUPERHIDROFILIA. Gracias a las propiedades de las fachadas Neolith, cuando llueve, el agua se expande sobre la superficie de manera uniforme, facilitando de esta forma el arrastre y la eliminación de las partículas de suciedad restantes. De esta forma la superficie queda totalmente limpia y sin marcas de agua.

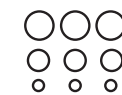

SELF-CLEANING



DECONTAMINATING



ANTI-BACTERIAL



ANTI-ODOR



ANTI-ALLERGEN

Strongfix System / Sistema

MIXED HIDDEN FASTENING SYSTEM

The most popular of our systems - called Strongfix system - is a ventilated facade solution that utilizes a dual fixation method -both mechanical and chemical- for enhanced safety. This concealed fixing system is designed for exterior facade cladding with Neolith panels in **6 mm and 12 mm thicknesses (approximately 1/4" and 1/2")**.

The system includes dead-load and wind-load brackets, along with vertical and horizontal rails, forming a robust metal framework.

For this facade system, a double 45° dovetail groove is pre-fabricated on the back of the panels at the Neolith factory. Additionally, horizontal rails called "hanger" and "closer" profiles are embedded into the Neolith panels, and the mechanical connection is reinforced with polyurethane sealant to maximize safety and strength.

These hanger/closer profiles act as the mechanism for suspending the panels onto the horizontal ("J" profile) supports. The Strongfix system is also designed for easy panel removal and replacement when required.

A minimum joint of 6 mm -both horizontally and vertically- between Neolith panels is recommended for proper installation.

SISTEMA MIXTO CON FIJACIÓN OCULTA

El sistema Strongfix es un sistema de fachada ventilada que dispone de doble fijación, mecánica y química, aportando así mayor seguridad al sistema. Es un sistema de fijación oculta que está concebido para el revestimiento exterior de fachadas con **paneles Neolith de espesor 6 mm y 12 mm**.

El sistema se compone de ménsulas o escuadras de sustentación y retención, perfiles verticales y horizontales formando un entramado metálico.

En este sistema de fachada se realiza previamente en fábrica, en la parte posterior de los paneles, un doble ranurado con un ángulo de 45° en forma de cola de milano y el montaje de los perfiles "Percha y Cierre" que van embebidos en el panel Neolith. Para mejorar esta unión se le aplica también masilla de poliuretano.

Estos perfiles Percha/cierre constituyen el mecanismo para poder colgar los paneles sobre los perfiles horizontales (perfil J).

El Sistema Strongfix también permite una fácil extracción y reemplazo cuando sea necesario.

Se recomienda una junta mínima, tanto horizontal como vertical, entre los paneles de Neolith de 6 mm.



HORIZONTAL SECTION DETAIL /
DETALLE SECCIÓN HORIZONTAL

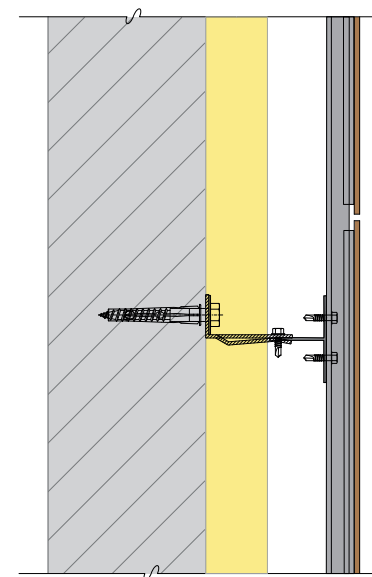

VERTICAL SECTION DETAIL /
DETALLE SECCIÓN VERTICAL

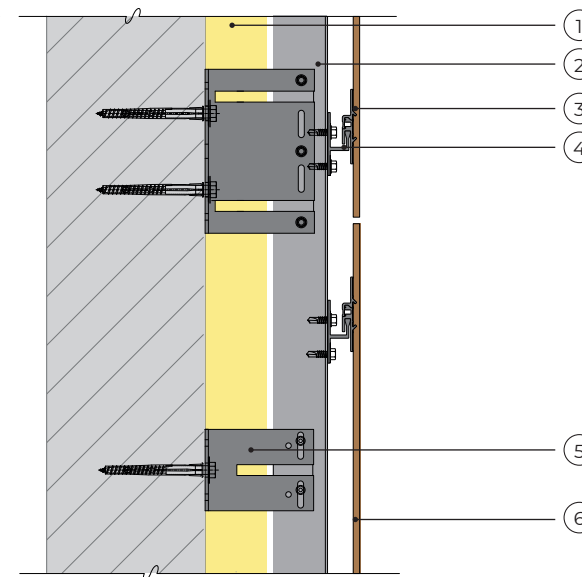

LEGEND / LEYENDA

1. Thermal insulation / Aislamiento térmico
2. Vertical "T" profile / Perfil vertical "T"
3. Hanger-closer profile / Perfil percha-cierre
4. J profile / perfil J
5. Aluminum brackets / Escuadras o ménsulas
6. Neolith slab / Panel Neolith

Strongfix System Installation

Instalación sistema Strongfix

STRONGFIX SYSTEM IS ICC-ES CERTIFIED

Neolith has received confirmation from ICC Evaluation Service, LLC (ICC-ES) that its Strongfix system complies with the provisions of the following codes: 2018, 2015, 2012, and 2009 International Building Code (IBC); and 2018, 2015, 2012, and 2009 International Residential Code (IRC).

This confirmation, included in the ICC-ES ESR-3659, provides guidance to specifiers facing the approval of the use of the Strongfix System under these codes. The evaluation report is available online at www.icc-es.org.

INSTALLATION

Versatile Facade Layout: The positioning of the brackets and vertical aluminum profiles is completely independent of the vertical joints in the facade panel layout, offering the architect complete freedom in design.

Installation of Vertical Profiles: The vertical rails are secured to the wall using one dead-load bracket and multiple wind-load brackets, depending on the project wind loads. These brackets are anchored to the substrate with the appropriate fasteners.

Installation of Horizontal Profiles: The "J" profiles are attached to the vertical profiles using self-drilling screws. The placement of the horizontal profiles should follow NEOLITH's shop drawings, prepared according to the architect's facade panel layout.

Installation of EPDM gaskets: Once the 'J' Profile is securely fastened, install EPDM gaskets every 25-30 cm (10-12") directly into the "J" profile to ensure a proper connection between the panel and the horizontal channel, preventing any potential movement caused by wind.

Installation of Neolith Cladding: Neolith panels come from the factory with the hanger/closer profiles already embedded into the back, allowing them to be easily hung from the 'J' Profile. Installation begins at the base of the facade and progresses upward. This system is designed for quick installation and facilitates easy panel replacement without damaging adjacent panels, if necessary.

EL SISTEMA STRONGFIX ESTÁ CERTIFICADO ICC-ES

Neolith ha recibido la confirmación de ICC Evaluation Service, LLC (ICC-ES), de que su sistema Strongfix cumple con las disposiciones de los códigos: 2018, 2015, 2012 y 2009 International Building Code (IBC); y 2018, 2015, 2012 y 2009 International Residential Code (IRC).

Esta confirmación, recogida en el informe de evaluación ICC-ES ESR-3659, proporciona orientación a los prescriptores que enfrentan la aprobación del uso del Sistema Strongfix bajo estos códigos. El informe de evaluación está disponible online en www.icc-es.org.

INSTALACIÓN

Replanteo de la fachada: disposición de los perfiles verticales de aluminio, los cuales pueden ser instalados independientemente de las juntas verticales.

Instalación de los perfiles verticales: la estructura vertical se ancla al muro usando escuadras de retención y sustentación y anclajes.

Instalación de los perfiles horizontales: es necesario determinar la posición de los perfiles horizontales, siguiendo el plano de montaje de la fachada. Esta estructura se fija a la estructura vertical con tornillos autotaladrantes.

Instalación de goma antivibración de EPDM: Una vez que el perfil «J» esté bien fijado, se instalarán las gomas de EPDM cada 25-30 cm (10-12") directamente en el perfil «J» para garantizar una conexión adecuada entre el panel y el perfil horizontal, evitando cualquier posible movimiento causado por el viento.

Instalación de las tablas Neolith: es necesario empezar desde el arranque de la fachada. Este sistema de fachada es muy rápido de instalar y permite el reemplazo de las baldosas si fuera necesario.



COMPONENT DETAILS / DETALLE DE COMPONENTES



Dead load bracket
Escuadra de sustentación



Wind load bracket
Escuadra de retención

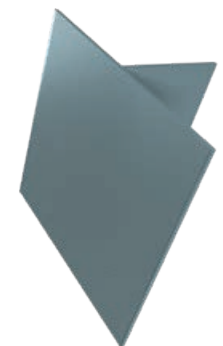

Vertical "T" profile
Perfil vertical "T"

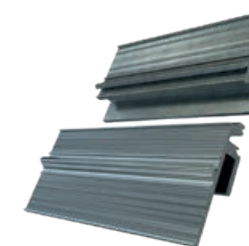

Hanger/closer profile web
Perfil percha/cierre con alma

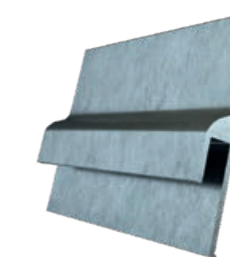

Hanger/closer profile no web
Perfil percha/cierre sin alma

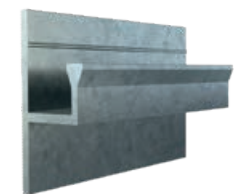

"J" profile
Perfil "J"

VM - Visible Mechanical System / Sistema

VISIBLE FIXING MIXED SYSTEM

The VM system is a dual ventilated facade system that combines both mechanical and chemical fixation, offering enhanced safety and stability. It is a visible fixing system designed for exterior facade cladding using **6 mm Neolith panels**.

For safety, a fiberglass mesh is applied to the back of the panels to prevent fragment detachment in the event of accidental breakage.

The system includes support and retention brackets, vertical profiles, and fastening clips to secure the Neolith cladding panels. The profiles and brackets are made of aluminum, while the clips, fasteners, and screws are constructed from AISI 304 stainless steel.

To improve the system's dimensional stability, a bead of elastic adhesive is applied along the vertical profiles, ensuring precise panel placement. This also enhances the system's performance under pressure, wind suction, and gravitational loads, while helping to absorb vibrations caused by wind.

For proper installation, it is recommended to maintain a minimum vertical joint of 5 mm and a minimum horizontal joint of 8 mm between panels, as required by the fastening clips.

SISTEMA MIXTO CON FIJACIÓN VISTA

El sistema VM es un sistema de fachada ventilada mixto, es decir, dispone de doble fijación, mecánica y química, aportando así mayor seguridad al sistema. Es un sistema de fijación vista que está concebido para el revestimiento exterior de fachadas con paneles Neolith de **6 mm de espesor**.

Por motivos de seguridad aplicamos una malla de fibra de vidrio en la parte posterior de los paneles para evitar desprendimientos de trozos en el caso que se produzcan roturas accidentales.

El sistema se compone de escuadras de sustentación y retención, perfiles verticales y grapas de sujeción de los paneles de revestimiento Neolith.

Tanto la perfilaría como las escuadras son de aluminio mientras que las grapas, fijaciones y tornillería de acero inoxidable AISI 304.

Para favorecer la estabilidad dimensional del sistema se aplica un cordón de adhesivo elástico a lo largo de los perfiles verticales, que asegura el correcto posicionamiento de los paneles mejorando las respuestas del sistema a las cargas de presión, succión de viento y gravitatorias, absorbiendo así las posibles vibraciones derivadas del viento.

En cuanto a la junta entre paneles se recomienda una junta mínima vertical de 5 mm y una junta horizontal mínima de 8 mm que viene marcada por las grapas de sujeción de los paneles.



HORIZONTAL SECTION DETAIL /
DETALLE SECCIÓN HORIZONTAL

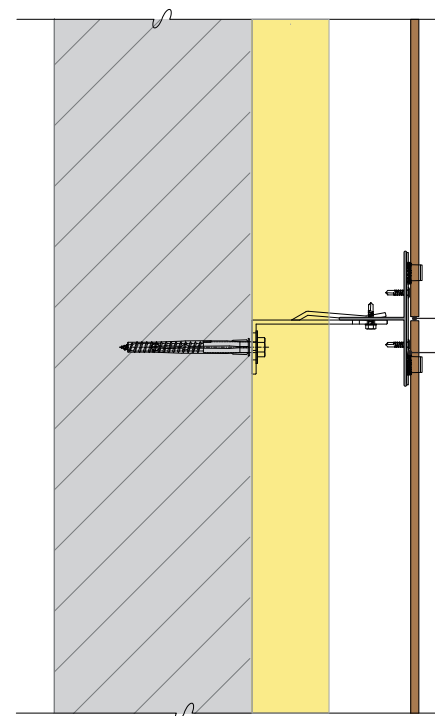

VERTICAL SECTION DETAIL /
DETALLE SECCIÓN VERTICAL

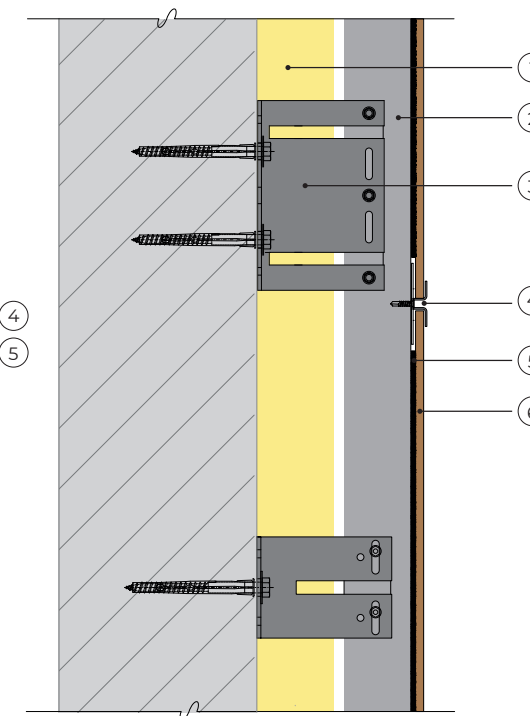

LEGEND / LEYENDA

1. Thermal insulation / Aislamiento térmico
2. Vertical aluminum "T" or "L" profile / Perfil vertical "T" o "L"
3. Aluminum brackets / Escuadras o ménsulas
4. Stainless steel clip or staple / Clip o grapa de acero inox
5. Adhesive / Adhesivo
6. Neolith slab / Panel Neolith

VM System Installation

Instalación del Sistema VM

DISTRIBUTION OF THE SUBSTRUCTURE AND INSTALLATION

The spacing between brackets, profiles, and clips are determined by factors such as the facade cladding design, the type of wall and/or building structure, and the specific location of the building.

The vertical profiles are securely installed on the wall using dead-load and wind-load brackets properly anchored to the substrate. These brackets ensure that the vertical profiles are properly leveled, allowing for the correction of any irregularities in the support wall behind the facade to be cladded.

DISTRIBUCIÓN DE LA SUBESTRUCTURA E INSTALACIÓN

Las distancias entre escuadras, perfiles y grapas dependerán del diseño del revestimiento de la fachada, del tipo de muro y/o estructura del edificio y de la ubicación del propio edificio.

La instalación de los perfiles verticales al muro soporte se realiza mediante el uso de escuadras de retención y sustentación mediante anclajes.

A través de las escuadras se consigue la correcta nivelación de los perfiles verticales, teniendo así la posibilidad de corregir las posibles irregularidades del muro soporte de la fachada a revestir.



COMPONENT DETAILS DETALLE DE COMPONENTES



Double central clip
Grapa doble intermedia



Simple central clip
Grapa simple intermedia



Simple start-finish clip
Grapa simple de
arranque/coronación



Double start-finish clip
Grapa doble de
arranque/coronación



Dead load bracket
Escuadra de sustentación



Wind load bracket
Escuadra de retención



Vertical "T" profile
Perfil vertical "T"



Vertical "L" profile
Perfil vertical "L"

INSTALLATION METHOD

The installation of panels should begin from the bottom rows and progress upward, ensuring the panels rest on the lower clips that have already been installed.

Once the brackets and profiles are securely in place, attach the clips using flat-head screws to prevent interference with the panel. The type of clips used will vary depending on the panel's location and its position.

Before placing the panel, apply a bead of adhesive onto the vertical profiles. Once the lower clips are in place and the adhesive has been applied, position the Neolith panel correctly and press it firmly until it makes contact with the adhesive. Finally, secure the upper clips of the panel, and repeat the process for the remaining panels.

For installing the final panels on the facade—such as at the top of the facade, at junctions with drip edges, or near terraces—follow this sequence for securing the upper clips:

1. Attach the clips to the profile using screws placed in the lower section of the slotted holes of the clip. Do not fully tighten these screws to allow for future adjustments.
2. Position the Neolith panel using the lower clips as support.
3. Slide the upper clips downward until they align with the panel.

MÉTODO DE APLICACIÓN

La instalación de los paneles se debe realizar desde las filas inferiores hacia las superiores, de manera que los paneles descansen sobre las grapas inferiores instaladas.

Una vez instaladas las escuadras y los perfiles correctamente se atornillarán las grapas con tornillos de cabeza extraplana para evitar que el panel tropiece con la cabeza del tornillo.

Se utilizarán diferentes tipos de grapa existentes según la ubicación de cada panel y su ubicación en el propio panel.

Previamente a la colocación del panel se aplicará un cordón de adhesivo sobre los perfiles verticales.

Una vez instaladas las grapas inferiores y el cordón de adhesivo se colocará el panel Neolith en la posición correcta y posteriormente se presionará firmemente hasta que contacte con el adhesivo. Por último se fijarán las grapas superiores del panel y se repetirá toda la secuencia con los demás paneles.

Para la colocación de los últimos paneles de fachada (ej: coronación de fachadas, encuentros con vierteaguas o terrazas, etc..) la secuencia de instalación de las grapas superiores sería la siguiente:

1. Fijación de las grapas al perfil con los tornillos en la parte inferior de los colisos verticales. No se deberá apretar al máximo los tornillos de estas grapas superiores para posteriormente poder desplazarlas.
2. Colocación del panel Neolith apoyándolo sobre las grapas inferiores.
3. Desplazar las grapas hacia abajo hasta que hagan tope con el panel.

HC Hidden Chemical System / Sistema

CHEMICALLY-FIXED HIDDEN SYSTEM

The HC (HIDDEN CHEMICAL) system is an exclusively chemically-attached, ventilated facade system featuring hidden fixings to the subframing. It is specifically designed for exterior facade cladding using **6 mm thick** Neolith panels

For safety reasons, a fiberglass mesh is applied to the back of the panels to prevent shattering caused by accidental breakage.

This system includes dead-load and wind-load brackets, vertical profiles, and a chemical adhesion system for the Neolith cladding panels, primarily based on polyurethane sealant.

Both the profiles and Neolith panels must be pre-treated for enhanced adhesion and then installed with polyurethane structural sealant and double-sided tape to ensure the panels stay in place during the curing process of the structural adhesive.

Irregularities in the substrate can be corrected by the in-and-out tolerance between the T-profile and the brackets, creating a perfectly plumb facade

A minimum horizontal and vertical joint of 5 mm between Neolith panels is recommended for proper installation.

SISTEMA OCULTO CON FIJACIÓN QUÍMICA

El sistema HC es un sistema de fachada ventilada exclusivamente químico y por tanto de fijación oculta. Está concebido para el revestimiento exterior de fachadas con paneles Neolith de **6 mm de espesor**.

Por motivos de seguridad aplicamos una malla de fibra de vidrio en la parte posterior de los paneles para evitar desprendimientos de trozos en el caso que se produzcan roturas accidentales.

Este sistema se compone de ménsulas o escuadras de sustentación y retención, perfiles verticales y sistema de adhesión químico de los paneles de revestimiento Neolith.

La fijación química está compuesta por pretratamientos tanto al perfil como a la tabla, (con la finalidad de mejorar la adhesión) cinta adhesiva doble cara y adhesivo.

A través de las escuadras de sustentación y retención se consigue la correcta nivelación de los perfiles verticales, teniendo así la posibilidad de corregir las posibles irregularidades del muro soporte de la fachada a revestir.

Se recomienda una junta mínima, tanto horizontal como vertical, entre los paneles de Neolith de 5 mm.



HORIZONTAL SECTION DETAIL /
DETALLE SECCIÓN HORIZONTAL

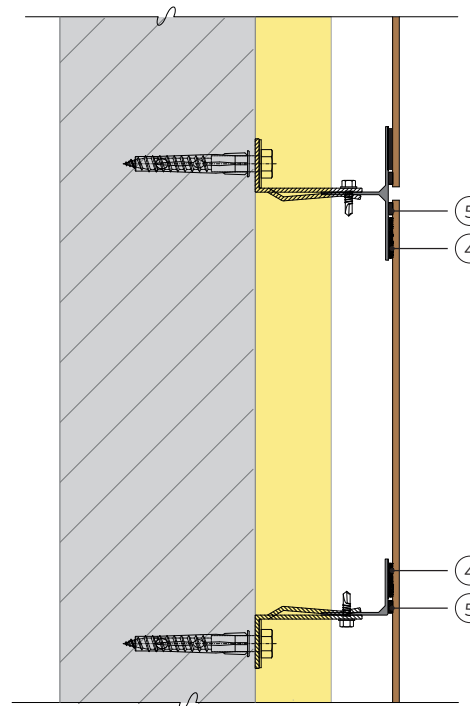

VERTICAL SECTION DETAIL /
DETALLE SECCIÓN VERTICAL

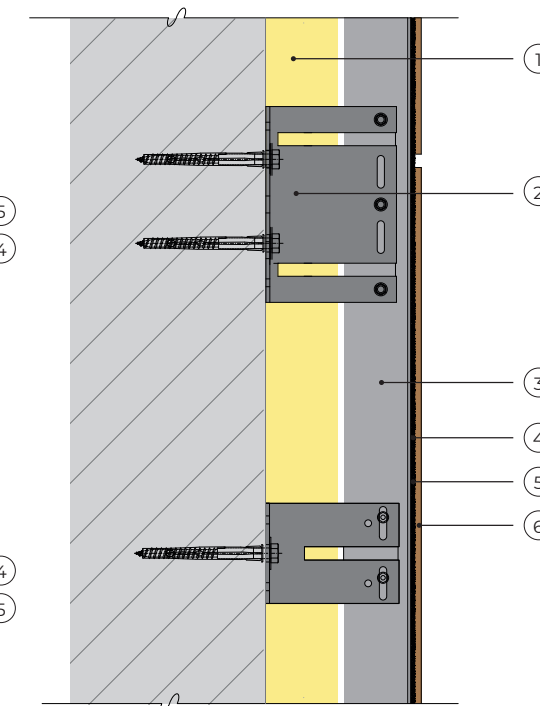

LEGEND / LEYENDA

1. Thermal insulation / Aislamiento térmico
2. Aluminum brackets / Escuadras o ménsulas
3. Vertical aluminum "T" or "L" profile / Perfil vertical "T" o "L"
4. Adhesive / Adhesivo
5. Double-sided adhesive tape / Cinta adhesiva doble cara.
6. Neolith slab / Panel Neolith

HC System Installation

Instalación del Sistema HC

DISTRIBUTION OF THE SUBSTRUCTURE AND INSTALLATION

Spacing between brackets and vertical profiles depends on the facade cladding design (joint location), as well as the type of substrate, project wind loads, and structural assumptions.

Vertical profiles are installed onto the dead-load and wind-load brackets, following the facade joints.

A pull-out test may be required to determine the substrate's load-bearing capacity before defining the bracket spacing.

DISTRIBUCIÓN DE LA SUBESTRUCTURA E INSTALACIÓN

Las distancias entre escuadras y perfiles dependerán del diseño del revestimiento de la fachada, del tipo de muro y/o estructura del edificio y de la ubicación del propio edificio.

La instalación de los perfiles verticales al muro soporte se realiza mediante el uso de escuadras de retención y sustentación mediante anclajes.

Una prueba de extracción para comprobar la resistencia a la tracción del muro podría ser requerida para determinar las distancias entre escuadras.



COMPONENT DETAILS / DETALLE DE COMPONENTES



Dead load bracket
Escuadra de sustentación



Wind load bracket
Escuadra de retención



Vertical "T" profile
Perfil vertical "T"



Vertical "L" profile
Perfil vertical "L"

HOW TO APPLY CHEMICAL FIXATION

Chemical fixation consists on the direct application of adhesive and double-sided self-adhesive strip to the vertical profiles. For optimal adhesion, it is essential to pre-treat both the Neolith panels and the vertical profiles. The general steps to be carried out are described below:

- 1. CLEANING.** Both the profiles (once fixed) and the panels must be free of dust or any other contaminants that could compromise the bond. For extremely dirty panels, clean using acetone or methyl ethyl ketone (avoid using turpentine).
- 2. APPLICATION OF THE ACTIVATOR.** After allowing the cleaning products to evaporate for 10 minutes, apply the activator to both the profile and the back of the panel, focusing on the area that will align with the profiles. Use disposable cellulose paper to apply the activator, rubbing from top to bottom and always in a single direction (avoid circular motions). Repeat the application as many times as needed until the paper no longer gets stained. Use a new piece of paper for each application.
- 3. APPLICATION OF THE PRIMER.** Once the activator has evaporated, apply a single coat of primer using a brush over the entire surface in contact with the adhesive, from top to bottom (not in a circle). It will also be applied both on the profile and on the surface of the panel that will be in touch with the adhesive.
- 4. APPLICATION OF THE DOUBLE-SIDED ADHESIVE STRIP.** Once the primer has dried (25 min. approx. depending on the manufacturer and atmospheric conditions) the double-sided adhesive strip should be applied vertically and continuously on the profiles. This strip is used for the initial fastening of the cladding panels until complete curing (or polymerization) of the adhesive and to ensure the correct dimensions of the adhesive bead.
- 5. ADHESIVE APPLICATION.** The adhesive should only be applied vertically and continuously, forming a triangular bead using the special V-shaped nozzle. The adhesive should always be applied between +5°C (41°F) and +35°C (95°F) of ambient temperature. Typically, two lines of elastic adhesive are applied along the vertical "T" profile, while a single line is applied on the "L" profile. Depending on the manufacturer, the adhesive must be applied within a maximum of 2 hours after the primer has been applied.
- 6. PANEL INSTALLATION.** The Neolith panel should be placed within 10 minutes of applying the adhesive, after removing the protective film from the double-sided strip. Once the panel is correctly positioned, it should be pressed firmly onto the profiles to ensure it makes contact with the strip. After the panel has made contact with the strip, no adjustments can be made.

COMO APLICAR LA FIJACIÓN QUÍMICA

La fijación química consiste en la aplicación directa sobre la perfilería vertical de adhesivo y cinta autoadhesiva de doble cara. Para una buena adhesión es imprescindible realizar pretratamientos previos tanto a los paneles Neolith como a los perfiles verticales. A continuación se describen los pasos generales a realizar:

- 1. LIMPIEZA.** Se limpiarán tanto los perfiles (una vez fijados) como los paneles de partículas de polvo u otro tipo de suciedad que pueda debilitar el pegado. Para casos de suciedad extrema limpiar con acetona o metiletilcetona (no aguarrás).
- 2. APLICACIÓN DEL PROMOTOR O ACTIVADOR.** Tras dejar evaporar 10 minutos los productos de limpieza se aplicará el promotor o activador al perfil y a la parte posterior del panel, concretamente en la superficie que coincide con los perfiles. Se aplicará mediante un papel de celulosa desechable frotando de arriba abajo (no en círculo) tantas veces como sea necesario hasta que es este no se manche y siempre en el mismo sentido. Desechar el papel con cada nueva pasada de aplicación.
- 3. APLICACIÓN DEL IMPRIMADOR.** Una vez evaporado el promotor aplicaremos una sola capa del imprimador mediante brocha o pincel sobre toda la superficie de contacto con el adhesivo, de arriba abajo (no en círculo). Al igual que el promotor se aplicará tanto al perfil como a la superficie del panel que estará en contacto con el adhesivo.
- 4. APLICACIÓN DE LA CINTA ADHESIVA DE DOBLE CARA.** Una vez que secado el imprimador (25 min. aprox. según fabricante y condiciones atmosféricas) se colocará la cinta adhesiva de doble cara a los perfiles de forma vertical y continua. Esta cinta se utiliza para la sujeción inicial de los paneles de revestimiento hasta el completo curado (o polimerización) del adhesivo y para asegurar las dimensiones correctas del cordón de adhesivo.
- 5. APLICACIÓN DEL ADHESIVO.** Se aplicará el adhesivo solamente de forma vertical y continua, formando un cordón triangular utilizando la boquilla especial en forma de V. Cabe reseñar que la aplicación del adhesivo se realizará siempre entre +5 °C (41°F) y +35 °C (95 °F) de temperatura. Generalmente se aplican dos cordones de adhesivo elástico a lo largo del perfil vertical "T" y un único cordón en el perfil "L". Según fabricantes existe un tiempo máximo de 2 h para aplicar el adhesivo desde que se ha aplicado la imprimación.
- 6. COLOCACIÓN DEL PANEL.** Se colocará el panel Neolith tras retirar el papel protector de la cinta adhesiva de doble cara y en menos de 10 minutos después de haber aplicado el adhesivo. Una vez que el panel haya sido posicionado de forma correcta, se presionará firmemente y se frotará para que haga contacto con la cinta. Una vez que el panel haya hecho contacto con la cinta no será posible hacer correcciones.

HC Slim Hidden Chemical System / Sistema

HIDDEN SYSTEM WITH CHEMICAL FIXATION WITHOUT REGULATION

This solution is designed for both interior and exterior wall cladding using **6 mm thick Neolith** panels. It features a hidden mounting system with a longitudinal chemical-elastic fixation applied to vertical 'Omega' profiles, placed directly at the joints between panels, and 'Z' profiles, positioned at the center of the panels to reinforce the attachment.

With a minimal space requirement of only 22 mm (7/8"), this system is ideal for cladding walls with very limited build-up space. Please note that this system does not offer build-up adjustment, so the wall must be perfectly plumb to ensure proper installation and optimal results.

For optimal installation, a minimum horizontal and vertical joint of 5 mm between Neolith panels is recommended.

SISTEMA OCULTO CON FIJACIÓN QUÍMICA SIN REGULACIÓN

Esta solución constructiva concebida tanto para el revestimiento de interiores como de exteriores con **paneles Neolith de 6 mm de espesor**.

Es un sistema de anclaje oculto utilizando una fijación longitudinal químico-elástica montada sobre perfiles verticales en forma de "Omega" o "Z", dependiendo de si los perfiles coinciden con las juntas entre paneles o perfiles intermedios de refuerzo.

Por el reducido espacio que ocupa el sistema (22 mm) lo hace idóneo para recubrir muros interiores que estén perfectamente aplomados.

Se recomienda una junta mínima, tanto horizontal como vertical, entre los paneles de Neolith de 5 mm.



HORIZONTAL SECTION DETAIL /
DETALLE SECCIÓN HORIZONTAL

VERTICAL SECTION DETAIL /
DETALLE SECCIÓN VERTICAL

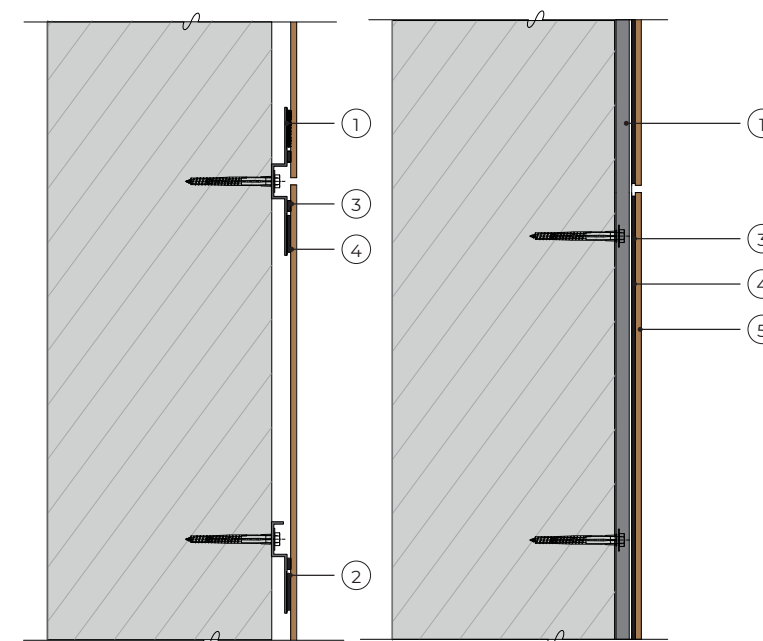

LEGEND / LEYENDA

1. Omega profile / Perfil Omega
2. Z profile / Perfil Z
3. Double-sided tape adhesive / Cinta adhesiva doble cara.
4. Adhesive / Adhesivo
5. Neolith slab / Panel Neolith

HC Slim System Installation

Instalación Sistema HC Slim

DISTRIBUTION OF THE SUBSTRUCTURE AND INSTALLATION

Spacing between profiles depends on the facade cladding design (joint location), as well as the type of substrate, project wind loads, and structural assumptions.

Vertical profiles are anchored directly to the substrate with the appropriate fasteners.

A pull-out test may be required to determine the substrate's load-bearing capacity before defining the profile spacing.

DISTRIBUCIÓN DE LA SUBESTRUCTURA E INSTALACIÓN

Las distancias entre perfiles dependerán del diseño del revestimiento de la fachada o muro, del tipo de muro y/o estructura del edificio y de la ubicación del propio edificio.

Una prueba de extracción para comprobar la resistencia a la tracción del muro podría ser requerida para determinar las distancias entre PERFILES VERTICALES.

La instalación de los perfiles verticales al muro soporte se realiza directamente al muro mediante anclajes fijos.



HOW TO APPLY CHEMICAL FIXATION

Chemical fixation consists on the direct application of adhesive and double-sided self-adhesive strip to the vertical profiles. For optimal adhesion, it is essential to pre-treat both the Neolith panels and the vertical profiles. The general steps to be carried out are described below:

- 1. CLEANING.** Both the profiles (once fixed) and the panels must be free of dust or any other contaminants that could compromise the bond. For extremely dirty panels, clean using acetone or methyl ethyl ketone (avoid using turpentine).
- 2. APPLICATION OF THE ACTIVATOR.** After allowing the cleaning products to evaporate for 10 minutes, apply the activator to both the profile and the back of the panel, focusing on the area that will align with the profiles. Use disposable cellulose paper to apply the activator, rubbing from top to bottom and always in a single direction (avoid circular motions). Repeat the application as many times as needed until the paper no longer gets stained. Use a new piece of paper for each application.
- 3. APPLICATION OF THE PRIMER.** Once the activator has evaporated, apply a single coat of primer using a brush over the entire surface in contact with the adhesive, from top to bottom (not in a circle). It will also be applied both on the profile and on the surface of the panel that will be in touch with the adhesive.
- 4. APPLICATION OF THE DOUBLE-SIDED ADHESIVE STRIP.** Once the primer has dried (25 min. approx. depending on the manufacturer and atmospheric conditions) the double-sided adhesive strip should be applied vertically and continuously on the profiles. This strip is used for the initial fastening of the cladding panels until complete curing (or polymerization) of the adhesive and to ensure the correct dimensions of the adhesive bead.
- 5. ADHESIVE APPLICATION.** The adhesive should only be applied vertically and continuously, forming a triangular bead using the special V-shaped nozzle. The adhesive should always be applied between +5°C (41°F) and +35°C (95°F) of ambient temperature. Typically, two lines of elastic adhesive are applied along the vertical "T" profile, while a single line is applied on the "L" profile. Depending on the manufacturer, the adhesive must be applied within a maximum of 2 hours after the primer has been applied.
- 6. PANEL INSTALLATION.** The Neolith panel should be placed within 10 minutes of applying the adhesive, after removing the protective film from the double-sided strip. Once the panel is correctly positioned, it should be pressed firmly onto the profiles to ensure it makes contact with the strip. After the panel has made contact with the strip, no adjustments can be made.

COMO APLICAR LA FIJACIÓN QUÍMICA

La fijación química consiste en la aplicación directa sobre la perfilera vertical de adhesivo y cinta autoadhesiva de doble cara. Para una buena adhesión es imprescindible realizar pretratamientos previos tanto a los paneles Neolith como a los perfiles verticales. A continuación se describen los pasos generales a realizar:

- 1. LIMPIEZA.** Se limpiarán tanto los perfiles (una vez fijados) como los paneles de partículas de polvo u otro tipo de suciedad que pueda debilitar el pegado. Para casos de suciedad extrema limpiar con acetona o metiletilcetona (no aguarrás).
- 2. APLICACIÓN DEL PROMOTOR O ACTIVADOR.** Tras dejar evaporar 10 minutos los productos de limpieza se aplicará el promotor o activador al perfil y a la parte posterior del panel, concretamente en la superficie que coincide con los perfiles. Se aplicará mediante un papel de celulosa desechable frotando de arriba abajo (no en círculo) tantas veces como sea necesario hasta que es este no se manche y siempre en el mismo sentido. Desechar el papel con cada nueva pasada de aplicación.
- 3. APLICACIÓN DEL IMPRIMADOR.** Una vez evaporado el promotor aplicaremos una sola capa del imprimador mediante brocha o pincel sobre toda la superficie de contacto con el adhesivo, de arriba abajo (no en círculo). Al igual que el promotor se aplicará tanto al perfil como a la superficie del panel que estará en contacto con el adhesivo.
- 4. APLICACIÓN DE LA CINTA ADHESIVA DE DOBLE CARA.** Una vez que secado el imprimador (25 mina prox. según fabricante y condiciones atmosféricas) se colocará la cinta adhesiva de doble cara a los perfiles de forma vertical y continua. Esta cinta se utiliza para la sujeción inicial de los paneles de revestimiento hasta el completo curado (o polimerización) del adhesivo y para asegurar las dimensiones correctas del cordón de adhesivo.
- 5. APLICACIÓN DEL ADHESIVO.** Se aplicará el adhesivo solamente de forma vertical y continua, formando un cordón triangular utilizando la boquilla especial en forma de V. Cabe reseñar que la aplicación del adhesivo se realizará siempre entre +5 °C (41°F) y +35 °C (95 °F) de temperatura. Generalmente se aplican dos cordones de adhesivo elástico a lo largo del perfil vertical "T" y un único cordón en el perfil "L". Según fabricantes existe un tiempo máximo de 2 h para aplicar el adhesivo desde que se ha aplicado la imprimación.
- 6. COLOCACIÓN DEL PANEL.** Se colocará el panel Neolith tras retirar el papel protector de la cinta adhesiva de doble cara y en menos de 10 minutos después de haber aplicado el adhesivo. Una vez que el panel haya sido posicionado de forma correcta, se presionará firmemente y se frotará para que haga contacto con la cinta. Una vez que el panel haya hecho contacto con la cinta no será posible hacer correcciones.

COMPONENT DETAILS / DETALLE DE COMPONENTES

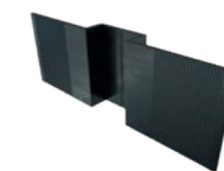

Hat Channel
Perfil "Omega"

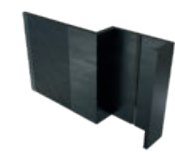

"Z" profile
Perfil "Z"

HC-R Hidden Chemical System / Sistema

HIDDEN SYSTEM WITH CHEMICAL FIXING AND SECURITY CLIP

The HC-R system is a hybrid solution, an enhanced version of the HC system that incorporates a security clip (mechanical anchorage) in a concealed manner. This additional reinforcement improves the system's overall performance. It is designed for the exterior cladding of facades using 6 mm thick Neolith panels.

For safety, a fiberglass mesh is applied to the back of the panels to prevent any fragments from detaching in case of accidental breakage.

This system includes dead load and wind load brackets, vertical profiles, and a chemical adhesion system for attaching the Neolith cladding panels. The chemical bonding process involves pre-treating both the profiles and the panels to improve adhesion, followed by the use of double-sided adhesive tape and adhesive.

A minimum joint of 5 mm, both horizontally and vertically, is recommended between the Neolith panels to ensure proper installation.

SISTEMA OCULTO CON FIJACIÓN QUÍMICA Y GRAPA DE SEGURIDAD

El sistema HC-R, es un sistema mixto, variante del sistema HC en la que se añade una grapa de seguridad (anclaje mecánico) de forma oculta, ofreciendo una alternativa con un refuerzo adicional que mejora las prestaciones del sistema original. Está concebido para el revestimiento exterior de fachadas con paneles Neolith de 6 mm de espesor.

Por motivos de seguridad aplicamos una malla de fibra de vidrio en la parte posterior de los paneles para evitar desprendimientos de trozos en el caso que se produzcan roturas accidentales.

Este sistema se compone de ménsulas o escuadras de sustentación y retención, perfiles verticales y sistema de adhesión químico de los paneles de revestimiento Neolith.

La fijación química está compuesta por pretratamientos tanto al perfil como a la tabla, (con la finalidad de mejorar la adhesión) cinta adhesiva doble cara y adhesivo.

Se recomienda una junta mínima, tanto horizontal como vertical, entre los paneles de Neolith de 5 mm.

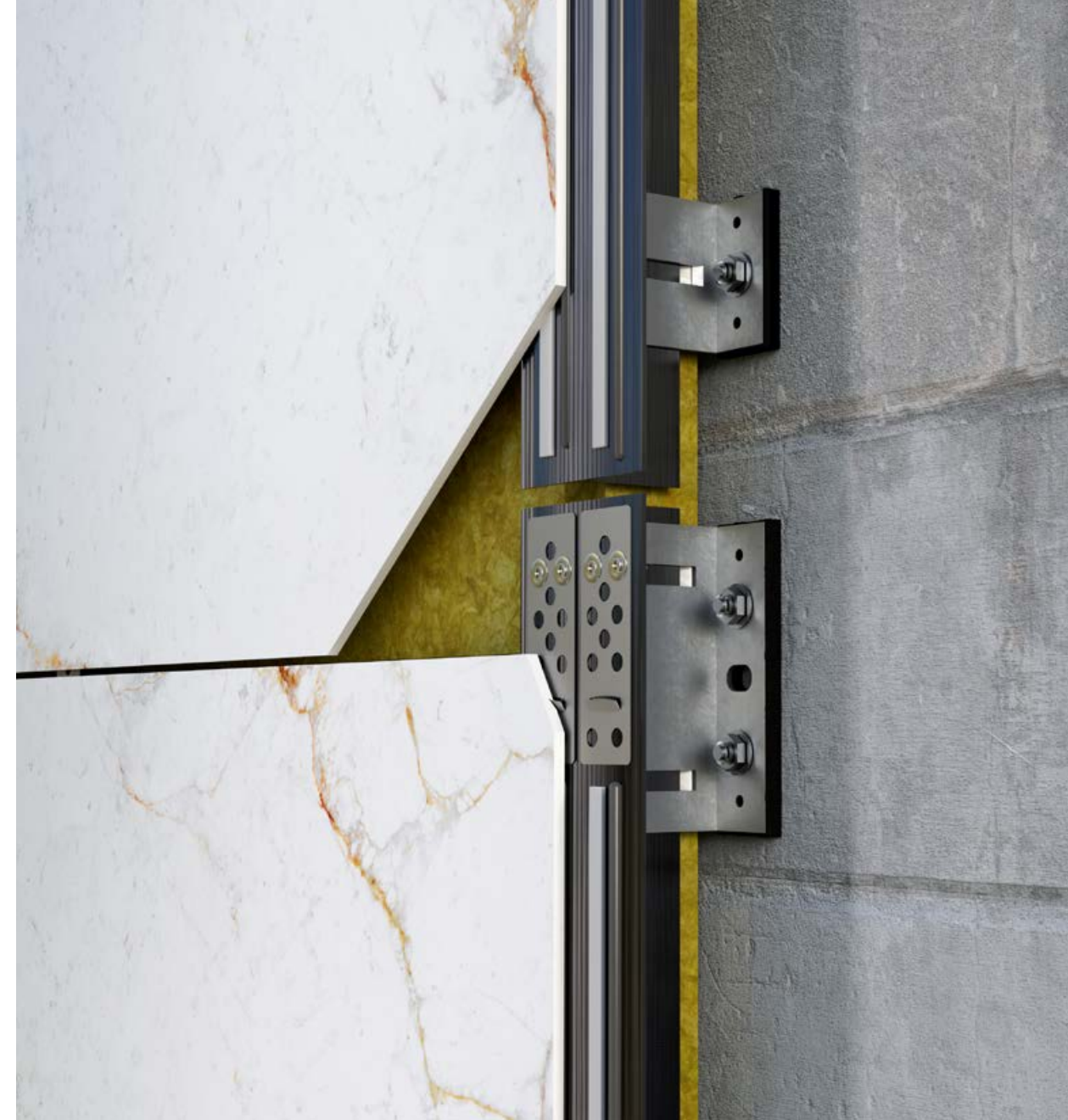

HORIZONTAL SECTION DETAIL /
DETALLE SECCIÓN HORIZONTAL

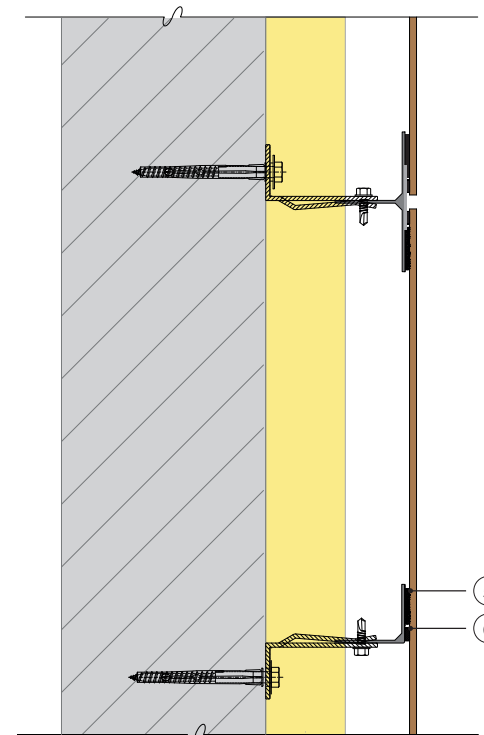

VERTICAL SECTION DETAIL /
DETALLE SECCIÓN VERTICAL

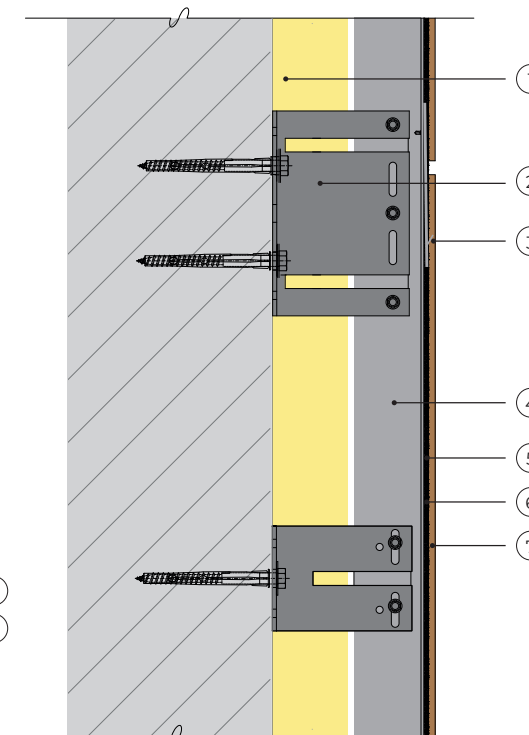

LEGEND / LEYENDA

1. Thermal insulation / Aislamiento térmico
2. Aluminum brackets / Escuadras o ménsulas
3. Clip / Grapa de seguridad
4. Vertical aluminum "T" or "L" profile / Perfil vertical "T" o "L"
5. Double-sided adhesive tape / Cinta adhesiva doble cara.
6. Adhesive / Adhesivo
7. Neolith slab / Panel Neolith

HC-R System Installation

Instalación del Sistema HC-R

Spacing between profiles depends on the facade cladding design (joint location), as well as the type of substrate, project wind loads, and structural assumptions.

Vertical profiles are installed onto the dead-load and wind-load brackets, following the facade joints.

These brackets ensure proper leveling of the vertical profiles, allowing for corrections to any irregularities in the supporting wall of the facade.

Before applying the pre-treatments for bonding, the panels are grooved at a 45° angle to accommodate the security clips. A small amount of adhesive is applied within the groove to fix the clip and seal the area. The number of clips required will depend on the dimensions of each panel, ensuring stability and reinforcement.

A pull-out test may be required to determine the substrate's load-bearing capacity before defining the profile spacing.

Las distancias entre escuadras, perfiles y grapas dependerán del diseño del revestimiento de la fachada, del tipo de muro y/o estructura del edificio y de la ubicación del propio edificio.

La instalación de los perfiles verticales al muro soporte se realiza mediante el uso de escuadras de retención y sustentación mediante anclajes.

A través de las escuadras se consigue la correcta nivelación de los perfiles verticales, teniendo así la posibilidad de corregir las posibles irregularidades del muro soporte de la fachada a revestir.

Antes de la aplicación de los pretratamientos para su pegado se le realizarán a los paneles un ranurado puntual a 45° para insertar las grapas de seguridad. Para fijar las grapas y sellar la ranura se aplicará previamente un poco de adhesivo. El número de grapas dependerá de las dimensiones del panel.



COMPONENT DETAILS / DETALLE DE COMPONENTES



Dead load bracket
Escuadra de sustentación



Wind load bracket
Escuadra de retención



Vertical "T" profile
Perfil vertical "T"



Vertical "L" profile
Perfil vertical "L"



Safety clip
Grapa de seguridad

HOW TO APPLY CHEMICAL FIXATION

Chemical fixation consists on the direct application of adhesive and double-sided self-adhesive tape to the vertical profiles. For optimal adhesion, it is essential to pre-treat both the Neolith panels and the vertical profiles. The general steps to be carried out are described below:

- 1. CLEANING.** Both the profiles (once fixed) and the panels must be free of dust or any other contaminants that could compromise the bond. For extremely dirty panels, clean using acetone or methyl ethyl ketone (avoid using turpentine).
- 2. APPLICATION OF THE ACTIVATOR.** After allowing the cleaning products to evaporate for 10 minutes, apply the activator to both the profile and the back of the panel, focusing on the area that will align with the profiles. Use disposable cellulose paper to apply the activator, rubbing from top to bottom and always in a single direction (avoid circular motions). Repeat the application as many times as needed until the paper no longer gets stained. Use a new piece of paper for each application.
- 3. APPLICATION OF THE PRIMER.** Once the activator has evaporated, apply a single coat of primer using a brush over the entire surface in contact with the adhesive, from top to bottom (not in a circle). It will also be applied both on the profile and on the surface of the panel that will be in touch with the adhesive.
- 4. APPLICATION OF THE DOUBLE-SIDED ADHESIVE TAPE.** Once the primer has dried (25 min. approx. depending on the manufacturer and atmospheric conditions) the double-sided adhesive tape should be applied vertically and continuously on the profiles. This tape is used for the initial fastening of the cladding panels until complete curing (or polymerization) of the adhesive and to ensure the correct dimensions of the adhesive bead.
- 5. ADHESIVE APPLICATION.** The adhesive should only be applied vertically and continuously, forming a triangular bead using the special V-shaped nozzle. The adhesive should always be applied between +5°C (41°F) and +35°C (95°F) of ambient temperature. Typically, two lines of elastic adhesive are applied along the vertical "T" profile, while a single line is applied on the "L" profile. Depending on the manufacturer, the adhesive must be applied within a maximum of 2 hours after the primer has been applied.
- 6. PANEL INSTALLATION.** The Neolith panel should be placed within 10 minutes of applying the adhesive, after removing the protective film from the double-sided tape. Once the panel is correctly positioned, it should be pressed firmly onto the profiles to ensure it makes contact with the tape. After the panel has made contact with the tape, no adjustments can be made. Once positioned, safety clips can be screwed into the vertical profiles.

COMO APLICAR LA FIJACIÓN QUÍMICA

La fijación química consiste en la aplicación directa sobre la perfilería vertical de adhesivo y cinta autoadhesiva de doble cara. Para una buena adhesión es imprescindible realizar pretratamientos previos tanto a los paneles Neolith como a los perfiles verticales. A continuación se describen los pasos generales a realizar:

- 1. LIMPIEZA.** Se limpiarán tanto los perfiles (una vez fijados) como los paneles de partículas de polvo u otro tipo de suciedad que pueda debilitar el pegado. Para casos de suciedad extrema limpiar con acetona o metiletilcetona (no aguarrás).
- 2. APLICACIÓN DEL PROMOTOR O ACTIVADOR.** Tras dejar evaporar 10 minutos los productos de limpieza se aplicará el promotor o activador al perfil y a la parte posterior del panel, concretamente en la superficie que coincide con los perfiles. Se aplicará mediante un papel de celulosa desechable frotando de arriba abajo (no en círculo) tantas veces como sea necesario hasta que es este no se manche y siempre en el mismo sentido. Desechar el papel con cada nueva pasada de aplicación.
- 3. APLICACIÓN DEL IMPRIMADOR.** Una vez evaporado el promotor aplicaremos una sola capa del imprimador mediante brocha o pincel sobre toda la superficie de contacto con el adhesivo, de arriba abajo (no en círculo). Al igual que el promotor se aplicará tanto al perfil como a la superficie del panel que estará en contacto con el adhesivo.
- 4. APLICACIÓN DE LA CINTA ADHESIVA DE DOBLE CARA.** Una vez que secado el imprimador (25 min. aprox. según fabricante y condiciones atmosféricas) se colocará la cinta adhesiva de doble cara a los perfiles de forma vertical y continua. Esta cinta se utiliza para la sujeción inicial de los paneles de revestimiento hasta el completo curado (o polimerización) del adhesivo y para asegurar las dimensiones correctas del cordón de adhesivo.
- 5. APLICACIÓN DEL ADHESIVO.** Se aplicará el adhesivo solamente de forma vertical y continua, formando un cordón triangular utilizando la boquilla especial en forma de V. Cabe reseñar que la aplicación del adhesivo se realizará siempre entre +5 °C (41°F) y +35 °C (95 °F) de temperatura. Generalmente se aplican dos cordones de adhesivo elástico a lo largo del perfil vertical "T" y un único cordón en el perfil "L". Según fabricantes existe un tiempo máximo de 2 h para aplicar el adhesivo desde que se ha aplicado la imprimación.
- 6. COLOCACIÓN DEL PANEL.** Se colocará el panel Neolith tras retirar el papel protector de la cinta adhesiva de doble cara y en menos de 10 minutos después de haber aplicado el adhesivo. Una vez que el panel haya sido posicionado de forma correcta, se presionará firmemente y se frotará para que haga contacto con la cinta. Una vez que el panel haya hecho contacto con la cinta no será posible hacer correcciones. Una vez colocado el panel podremos atornillar las grapas de seguridad a los perfiles verticales. A diferencia del Sistema HC este sistema al disponer de grapas de seguridad se tendrá que montar de abajo a arriba.

HR Hidden Recessed Groove System / Sistema

HIDDEN MECHANICAL VENTILATED FAÇADE SYSTEM

This system consists of brackets, vertical profiles, and horizontal profiles, all constructed from aluminum. Similar to the Strongfix System, it offers the flexibility to create various cladding designs using the same profile configuration. Panels can be installed with aligned joints, staggered joints, or random joints, allowing for diverse aesthetic possibilities.

For optimal installation, it is recommended to maintain a **minimum vertical joint of 5 mm** between panels, along with a minimum horizontal joint of 6 mm, which is determined by the spacing of the horizontal profiles.

SISTEMA DE FACHADA VENTILADA OCULTO Y EXCLUSIVAMENTE MECÁNICO

Este sistema está compuesto por ménsulas, perfiles verticales y perfiles horizontales, todos ellos fabricados con aluminio.

Los paneles NEOLITH se apoyarán directamente sobre los perfiles horizontales a modo de guías o rieles, tras realizar previamente un mecanizado en continuo en los cantos de los paneles.

Al igual que el Sistema Strongfix tiene la ventaja de permitir diferentes diseños de revestimientos con la misma configuración de perfiles. Se podrán instalar tanto a junta corrida como a matajuntas o junta perdida.

En cuanto a la junta entre paneles se recomienda una **junta mínima vertical de 5 mm** y una junta horizontal mínima de 6 mm que viene marcada por los perfiles horizontales.



HORIZONTAL SECTION DETAIL /
DETALLE SECCIÓN HORIZONTAL

VERTICAL SECTION DETAIL /
DETALLE SECCIÓN VERTICAL

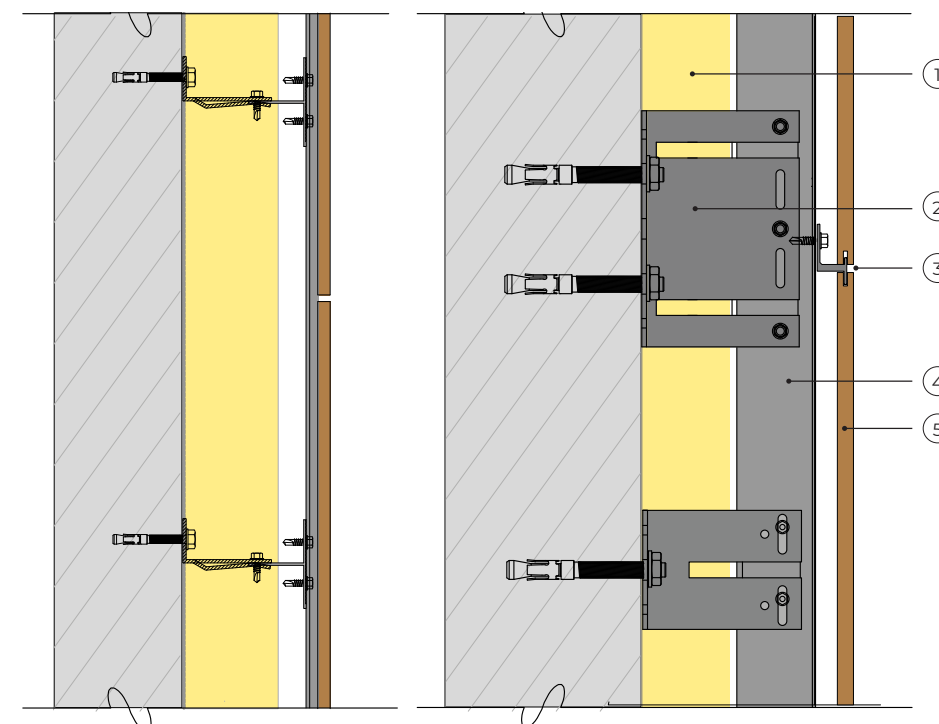

LEGEND / LEYENDA

1. Thermal insulation / Aislamiento térmico
2. Aluminum brackets / Escuadras o ménsulas
3. Central horizontal profile / Perfil horizontal central
4. Vertical aluminum "T" or "L" profile / Perfil vertical "T" o "L"
5. Neolith slab / Panel Neolith

HR System Installation

Instalación del Sistema HR

INSTALLATION

The installation of the vertical profiles to the substrate is achieved using dead-load and wind-load brackets, which are securely anchored. These brackets ensure proper leveling of the vertical profiles and allow for adjustments to correct any irregularities in the supporting wall of the façade.

Once the vertical profiles are installed, the horizontal profiles -varying based on their position on the façade- are attached to the vertical profiles using self-drilling screws.

Panel installation occurs concurrently with the attachment of the horizontal profiles, starting from the bottom and working upward. Prior to positioning the panels, a polyurethane sealant is applied to the grooved edges to prevent movement caused by wind and address any gaps in the recessed grooves.

INSTALACIÓN

La instalación de los perfiles verticales al muro soporte se realiza mediante el uso de escuadras de retención y sustentación mediante anclajes. Con las escuadras se consigue la correcta nivelación de los perfiles verticales, teniendo así la posibilidad de corregir las irregularidades del muro soporte de la fachada a revestir.

Una vez instalados los perfiles verticales se fijarán los perfiles horizontales (diferenciados según su ubicación en la fachada) que van atornillados directamente sobre el perfil vertical con tornillos autotaladrantes.

La colocación de los paneles se realizará a la vez que los perfiles horizontales y de abajo a arriba. Previa a la colocación del panel se aplicará masilla de poliuretano al ranurado del canto de los paneles para evitar movimientos debidos al viento y la holgura de las ranuras.



COMPONENT DETAILS / DETALLE DE COMPONENTES



Dead load bracket
Escuadra de sustentación



Wind load bracket
Escuadra de retención



Vertical "T" profile
Perfil vertical "T"



Vertical "L" profile
Perfil vertical "L"



Horizontal start profile
Perfil horizontal de arranque



Central horizontal profile
Perfil horizontal central



End horizontal profile
Perfil horizontal de coronación

HU Hidden Undercut System / Sistema

HIDDEN UNDERCUT SYSTEM

The HU system is a fully mechanical ventilated facade solution, specifically designed for Neolith panels with **thicknesses of 12 mm or 20 mm.**

For safety, a fiberglass mesh is applied to the back of the panels to prevent the detachment of pieces in case of accidental breakage.

This system is composed of brackets, vertical profiles, horizontal profiles, and clips, all made from aluminum. The horizontal profiles are fixed to the vertical profiles, creating a structural framework. These horizontal profiles feature a male-shaped section, while the clips, which have a female section, are affixed to the back of the Neolith panels using an expansion anchor (Keil anchor). Before installing the expansion anchor, a countersunk hole is drilled into the Neolith panel.

The Neolith panels, with the clips already installed, are then hung on the horizontal profiles. The design of the clips allows for horizontal tilt adjustments to the facade plane once a panel is in place.

For proper installation, a minimum joint of 5 mm is recommended between Neolith panels, both horizontally and vertically.

SISTEMA OCULTO DESTALONADO

El sistema HU es un sistema de fachada ventilada exclusivamente mecánico, concebido para paneles de Neolith de **espesores 12 o 20 mm.**

Por motivos de seguridad aplicamos una malla de fibra de vidrio en la parte posterior de los paneles para evitar desprendimientos de trozos en el caso que se produzcan roturas accidentales.

Este sistema está compuesto por ménsulas, perfiles verticales, perfiles horizontales y grapas. Todos los elementos están fabricados en aluminio.

Los perfiles horizontales irán fijados sobre los perfiles verticales formando un entramado estructural. Estos perfiles horizontales tienen una sección en forma de macho.

Las grapas, con sección hembra, se fijan en la parte posterior de las tablas Neolith mediante un taco expansivo (taco Keil). Para la instalación de este tipo de anclajes expansivos se realiza previamente un taladro destalonado a la placa de Neolith.

Finalmente las tablas Neolith con las grapas instaladas son colgadas sobre los perfiles horizontales.

Debido al diseño de las grapas este sistema, una vez instalada una placa, dispone de regulación en el plano vertical de la fachada.

Se recomienda una junta mínima, tanto horizontal como vertical, entre los paneles de Neolith de 5 mm.



HORIZONTAL SECTION DETAIL /
DETALLE SECCIÓN HORIZONTAL

VERTICAL SECTION DETAIL /
DETALLE SECCIÓN VERTICAL

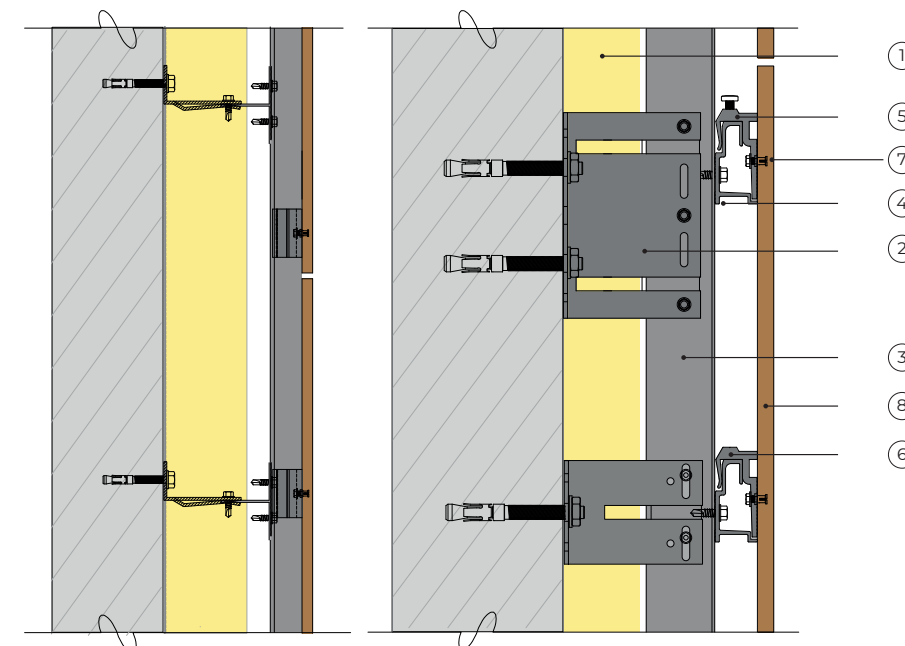

LEGEND / LEYENDA

1. Thermal insulation / Aislamiento térmico
2. Aluminum bracket / Escuadras o ménsulas
3. Aluminum vertical profile / Perfil vertical de aluminio "T 80x50x2"
4. Horizontal profile / Perfil horizontal
5. Adjustable hanger clip / Grapa cuelgue regulable
6. Hanger clip / Grapa cuelgue
7. Keil anchor / Anclaje Keil
8. Neolith slab / Panel Neolith

HU System Installation

Instalación del Sistema HU

INSTALLATION

Facade Layout: The positioning of the brackets and vertical aluminum profiles can be done independently of the vertical joints in the facade layout.

Installation of Vertical Profiles: The vertical profiles are secured to the wall using support and retention brackets with anchors to ensure stability.

Installation of Horizontal Profiles: The horizontal profiles are attached to the vertical profiles using self-drilling screws. The exact placement of the horizontal profiles should follow the facade layout plan.

Installation of Neolith Cladding: Once the clips are fixed to the back of the Neolith panels using expansion anchors, the installation starts from the base of the facade. This facade system allows for quick installation and makes it easy to replace tiles if necessary.

INSTALACIÓN

Replanteo de la fachada: disposición de las ménsulas y los perfiles verticales de aluminio, los cuales pueden ser instalados independientemente de las juntas verticales del despiece de la fachada.

Instalación de los perfiles verticales: la estructura vertical se fija al muro usando escuadras de sustentación y de retención mediante anclajes.

Instalación de los perfiles horizontales: se fijarán a los perfiles verticales mediante tornillos autotaladrantes. Será necesario determinar la posición de los perfiles horizontales siguiendo el plano de montaje del despiece de la fachada.

Instalación del revestimiento Neolith: una vez fijadas las grapas a la parte posterior los paneles Neolith con el anclaje expansivo, se empezarán a instalar desde el arranque de la fachada. Este sistema de fachada es muy rápido de instalar y permite el reemplazo de los paneles si fuera necesario.



Neolith slab
Tabla Neolith



COMPONENT DETAILS / DETALLE DE COMPONENTES



Dead load bracket
Escuadra de sustentación



Wind load bracket
Escuadra de retención



Vertical "T" profile
Perfil vertical "T"



Vertical "L" profile
Perfil vertical "L"

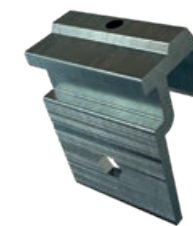

Adjustable hanger clip
Grapa cuelgue regulable

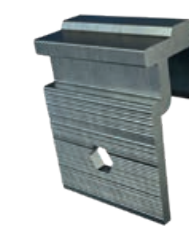

Hanger clip
Grapa cuelgue



Horizontal profile
Perfil horizontal

Technical assessment and design-assist

Our Projects technical team consists of highly specialized professionals, including architects, engineers, and drafters, who provide comprehensive support in selecting the most suitable ventilated facade system for each project, ensuring both technical performance and design excellence.

THE SERVICES WE OFFER INCLUDE:

- Guidance in choosing the right system to meet project requirements and budget.
- Assistance in selecting collections.
- Specification and development of technical drawings.
- Training for installation companies on system installation.

Additionally, Neolith offers PKs, CPDs, CEUs and specialized training for architecture firms and facade installers, supporting the ongoing professional development of design teams as well as ensuring proper jobsite performance.

For technical enquiries, please email projects@neolith.com

Asistencia técnica y desarrollo de proyectos

Nuestro equipo de Proyectos está compuesto por profesionales altamente especializados, incluyendo arquitectos, ingenieros y delineantes, quienes brindan asesoría integral en la selección del sistema de fachadas ventiladas más adecuado para cada proyecto, asegurando tanto la calidad técnica como la excelencia en diseño.

LOS SERVICIOS QUE OFRECEMOS INCLUYEN:

- Asesoría en la elección del sistema adecuado para cumplir con los requisitos del proyecto y el presupuesto.
- Orientación en la selección de colecciones.
- Especificación y desarrollo de dibujos técnicos.
- Formación en la instalación de sistemas para empresas instaladoras.

Además, Neolith ofrece programas de Capacitaciones técnicas, CPDs, CEUs y formación especializada para estudios de arquitectura y empresas instaladoras, contribuyendo al desarrollo profesional continuo de los equipos de diseño y garantizando una correcta ejecución en obra.

Para cualquier consulta técnica, puede enviar un email a projects@neolith.com

10-Year warranty / Garantía 10 años

Neolith offers a 10-Year warranty for its sintered stone products in Silk finish used as wall cladding.

For warranty conditions, please check the QR code below.

Neolith ofrece una garantía de 10 años para sus productos de piedra sinterizada en acabado Silk utilizados como revestimiento de paredes.

Para las condiciones de la garantía, por favor, compruebe el código QR a continuación.





SKYLINE

Neolith is the material of choice for architects and designers seeking innovative exterior cladding solutions. Ideal for bonded facades and rainscreens.

Neolith enhances the aesthetics of any building with its sleek, modern appearance. Made from 100% natural, durable materials, this sintered stone surface is available in a wide range of hyper-realistic colors and patterns, offering endless possibilities to inspire design innovation while ensuring long-lasting performance.

Neolith es el material preferido por arquitectos y diseñadores que buscan soluciones innovadoras de revestimiento exterior.

Ideal para fachadas pegadas y vierteaguas, Neolith realza la estética de cualquier edificio con su aspecto elegante y moderno. Fabricada a partir de materiales 100% naturales y duraderos, esta superficie de piedra sinterizada está disponible en una amplia gama de colores y patrones hiperrealistas, ofreciendo infinitas posibilidades para inspirar la innovación en el diseño, al tiempo que garantiza un rendimiento duradero.

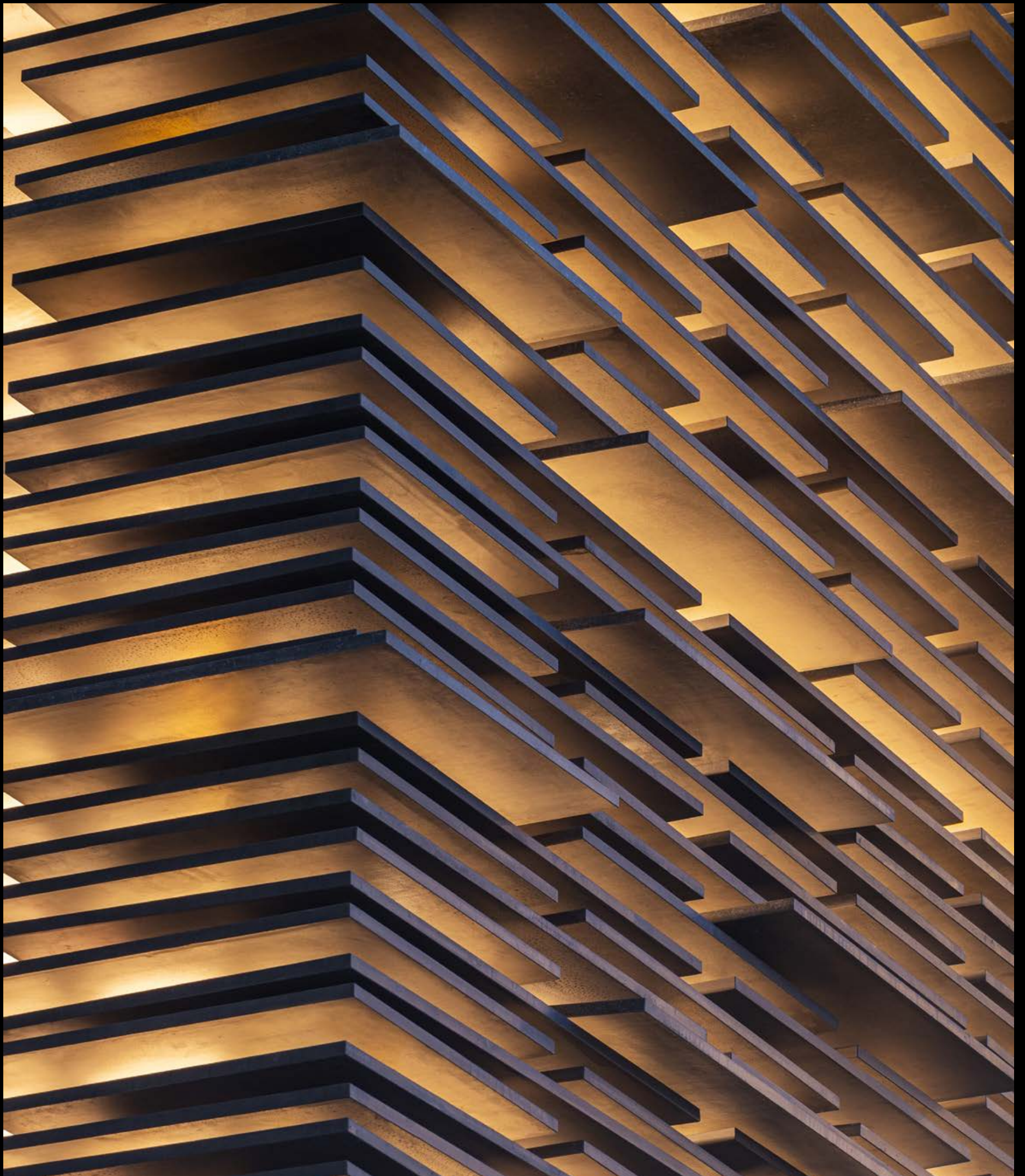



CHASE CENTER,
San Francisco, (USA)

Cladding system: Strongfix System
Design: Manica Architecture & Gensler
Image: Misha Bruck



FLARE OF FRANKFURT,
Frankfurt, (Germany)

Cladding System: Lithodecor Airtech System
Designed by: Hadi Therani
Installed by: Lithodecor
Images: Oleksandr Telesniuk





TECHSIZE BY NEOLITH
Nanjing, (China)

Cut-to-size
Custom system



THE SCIENCE TECHNOLOGY MUSEUM,
Ottawa, (Canada)

Design: Norr Limited Ottawa
Installed: Ontario Panelization
Cladding system: Ceramitex



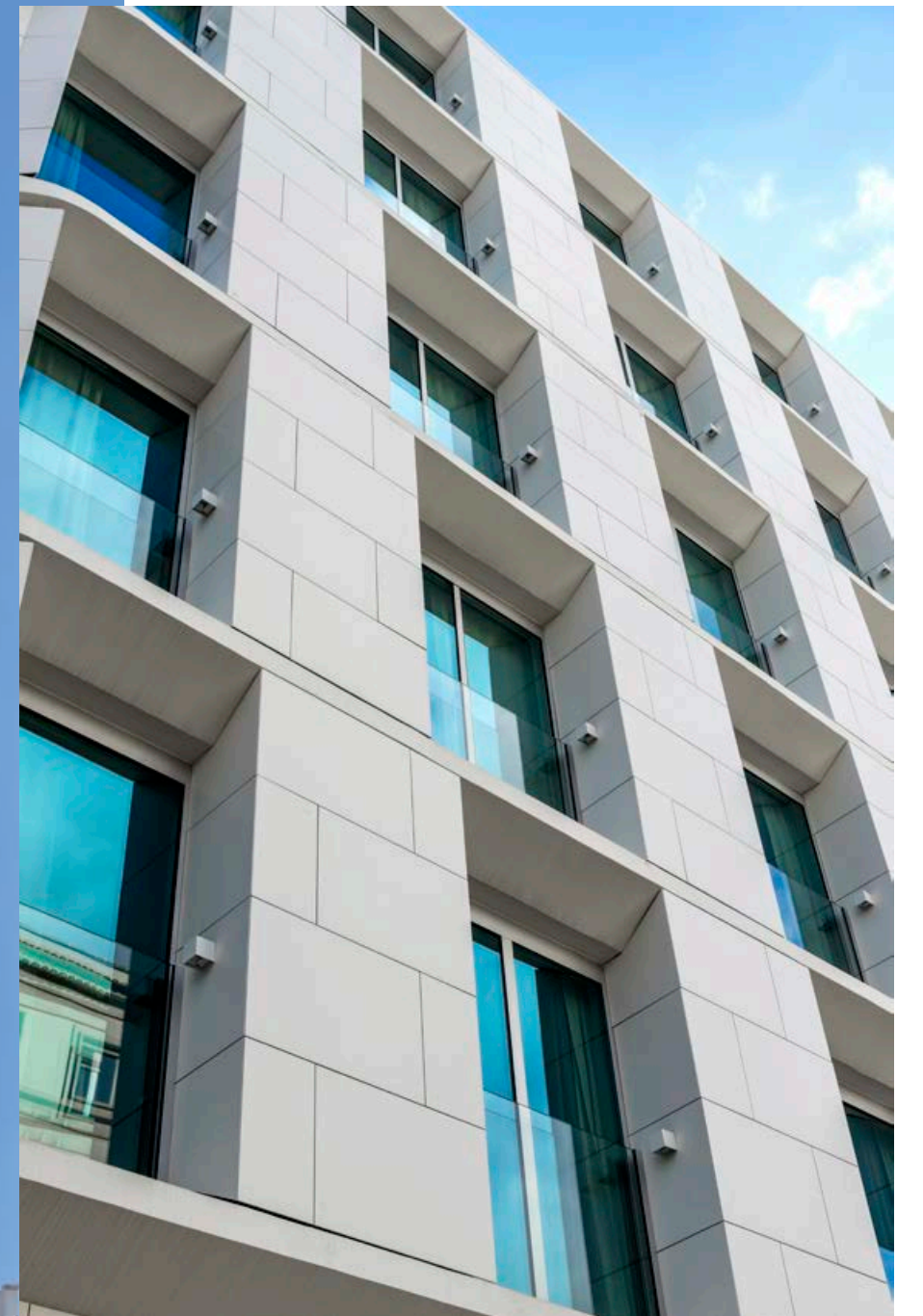

CEU UNIVERSO STUDENT RESIDENCE,
Lisbon, (Portugal)

Ventilated facade: Just White Silk
Image: Neolith Branding Team
Cut-to-size
Custom system

Neolith Jura
6 MM - 1/4"

CUSTOM MADE
COLOR

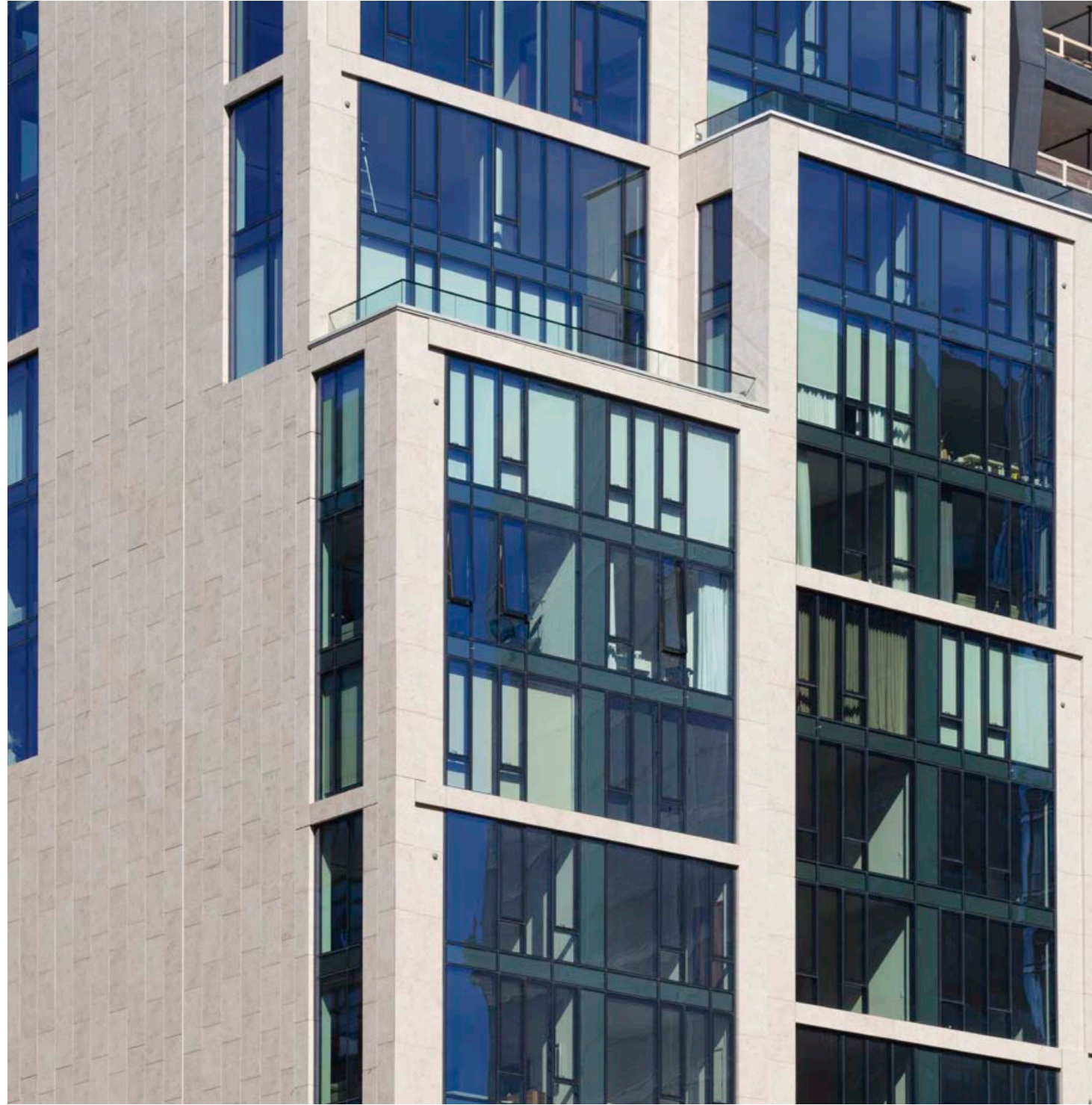

570 BROOME STREET
New York, (USA)

Cladding system: StrongFix System
Design: Tahir Demircioglu - BuiltD
Image: Matthew Carasella

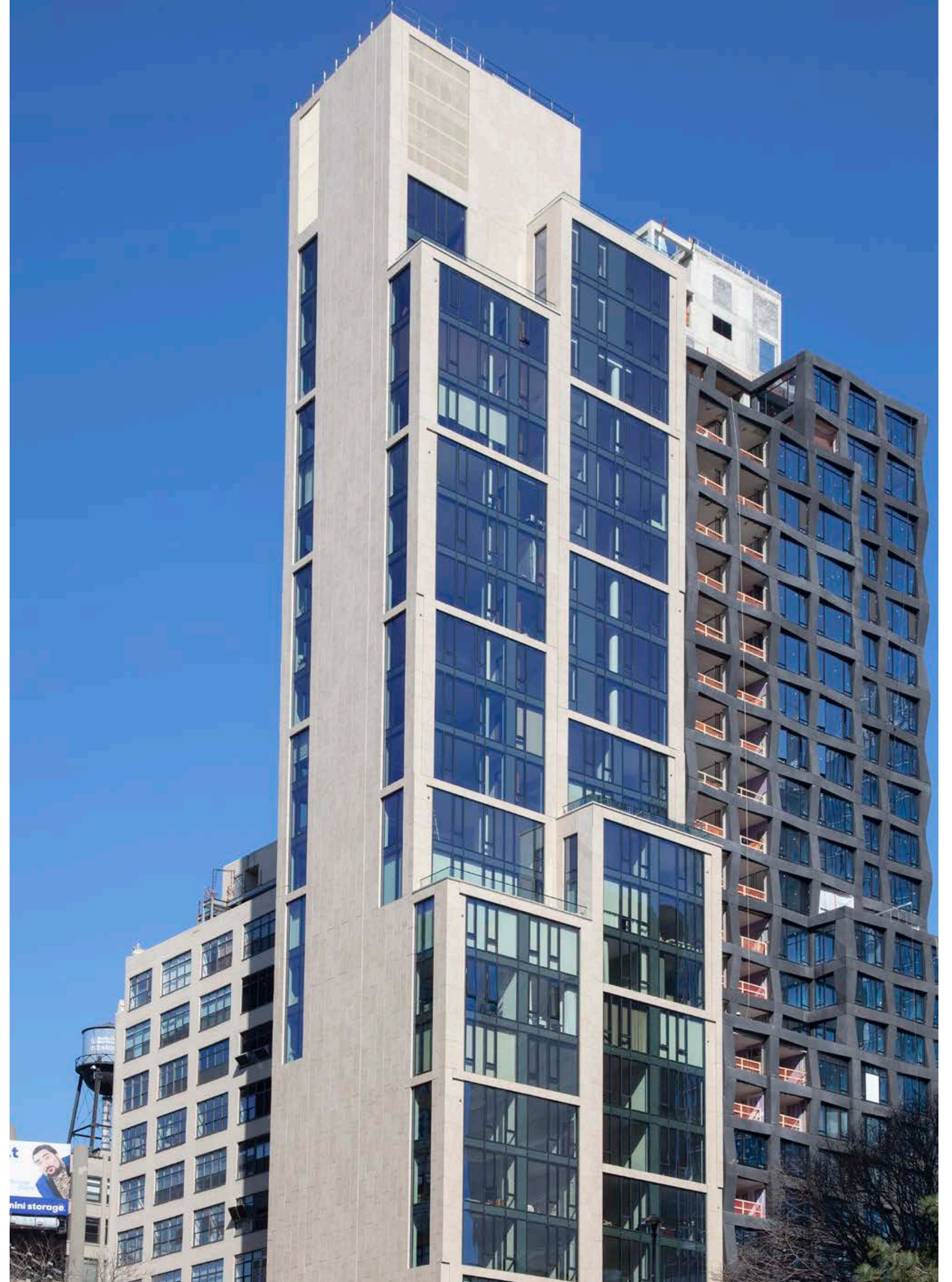

PROJECTS



NANNING ZHANGTAI INTELLIGENCE CITY,
Nanning, (China)

Ventilated facade: Iron Corten
Design: Huayang Design
Image: Shili Photography



SEVENTY HOTEL,
Barcelona, (Spain)

Design: OAB
Image: Neolith Branding Team



Iron Corten Satin | IRON
6 MM - 1/4"

LA QUINTA HOTEL,
Lovefield Airport, Dallas (USA)

Cladding system: HC System
Design: Mayse and Associates
Image: Neolith Branding Team



Just White Silk
6 MM - 1/4" | COLORFEEL



AXS NAMUR
Namur, (Belgium)

Cladding system: VM System
Design: Montois Architects
Image: Philippe Piraux Photographer

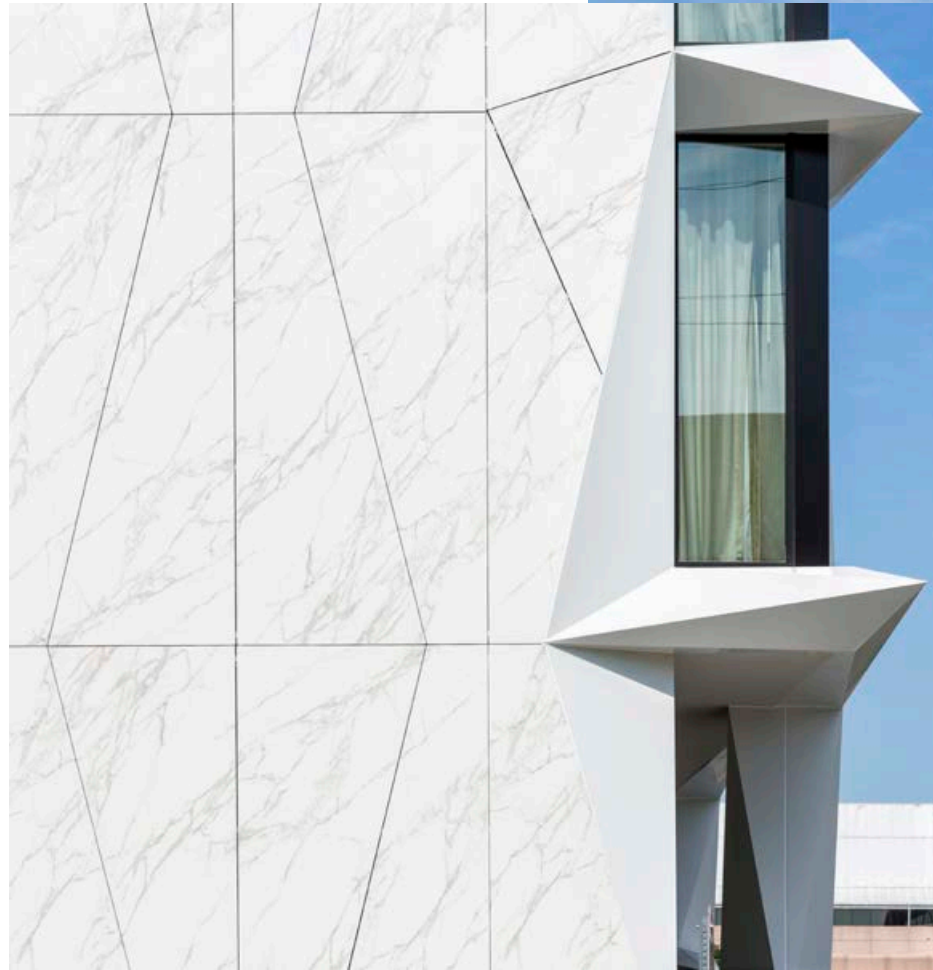

AC MARRIOT INTERNATIONAL DALLAS
Dallas (USA)

Ventilated Façade: Calacatta Silk 6 mm
Cladding System: StrongFix System
Design: 5G Studio
Installation: Holland Marble

Arctic White Satin | COLORFEEL
6+ MM - 1/4"



CLUB NÀUTIC PORT D'ARO
Girona, (Spain)

Cut-to-size
Cladding System: StrongFix System
Design: Abx Arquitectura
Installation: Wandegar
Image: Ainhoa Anaut



CHC MONTLÉGIA HOSPITAL,
Liège, (Belgium)

Cladding system: HC System
Design: Assar Architects
Image: Marc Detiffe



PARAGON APARTMENTS
Christchurch, (New Zealand)

Ventilated Façade: Basalt Beige Satin 3mm
Cladding System: HC System
Images: Jason Mann

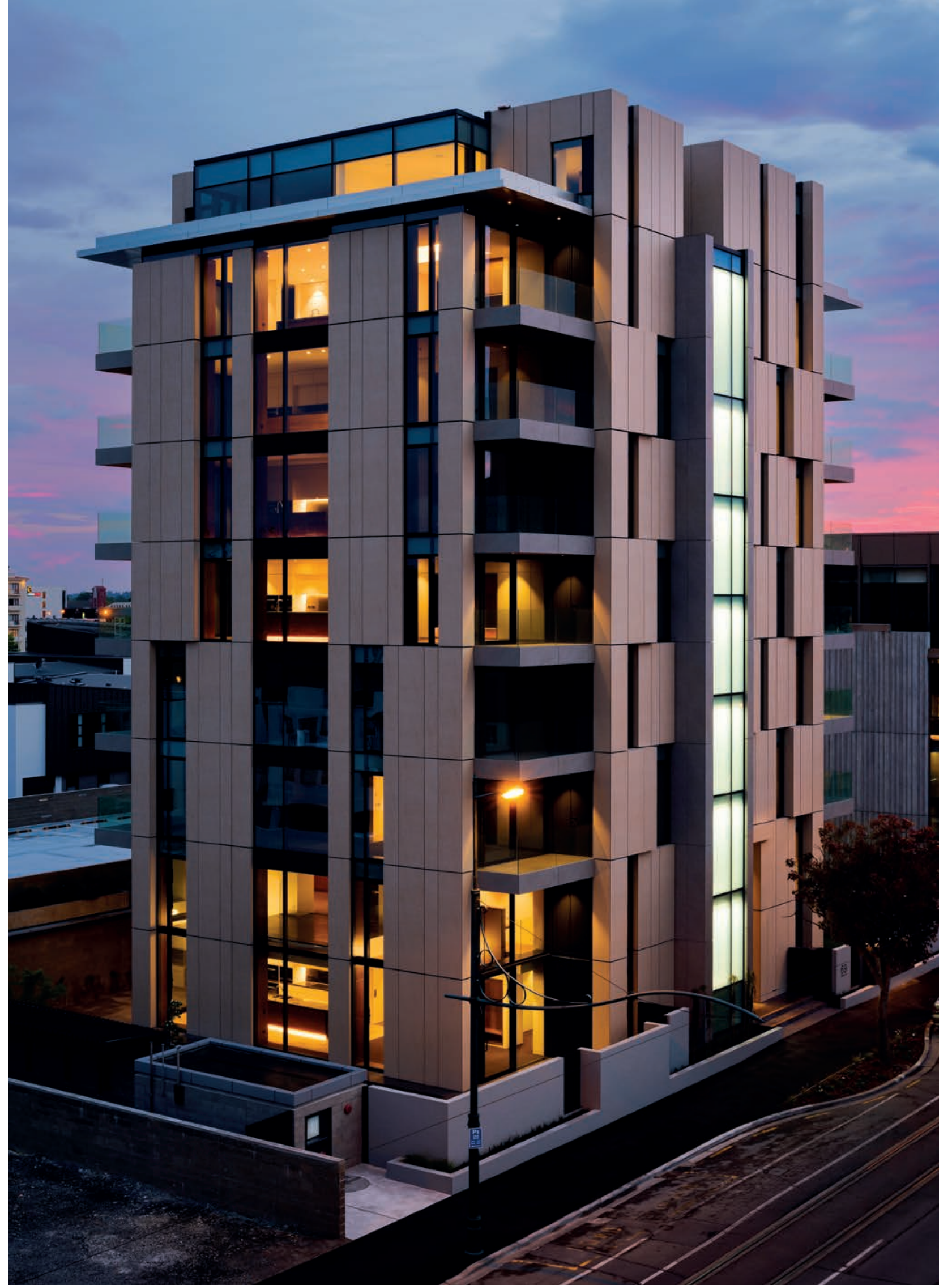

Just White Silk | COLORFEEL
6+ MM - 1/4"

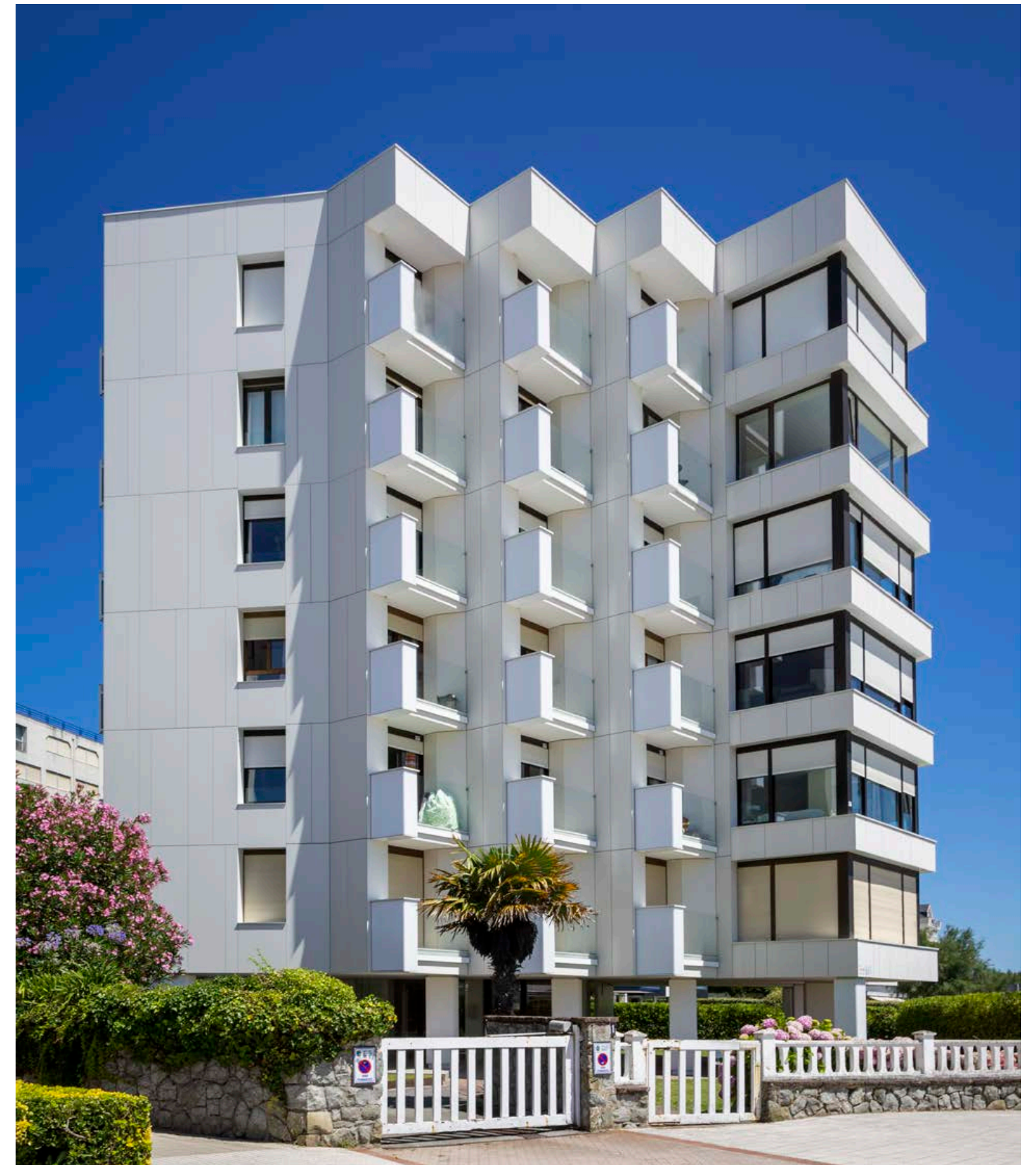

PROJECTS

GARCÍA LAGO APARTMENTS
Camargo - Cantabria, (Spain)

Cut-to-size
Design: Javier Saez de Santa Maria
Installation: Agüero Sandi
Cladding System: HC System
Image: Ainhoa Anaut



INTERMOUNTAIN HEALTH
Lehi, Utah

Design: VCBO Architecture
Installation: IMS Masonry
Cladding System: Strongfix
Image: Tim Gormley

Strata Argentum Riverwashed
6 MM+ - 1/4"

THE NEW
CLASSTONE



INTERMOUNTAIN HEALTH
Lehi, Utah

Design: VCBO Architecture
Installation: IMS Masonry
Cladding System: Strongfix
Image: Tim Gormley

Arctic White Silk | COLORFEEL
6+ MM - 1/4"



OFFICE BUILDING
Madrid, Spain

Design: Riaño Arquitectura
Installation: Grupo Liñagar
Image: Ainhoa Anaut
Cladding System: VM System

Neolith Jura
6+ MM - 1/4"

CUSTOM MADE
COLOR



UConn DORMITORY,
Storrs, CT (USA)

Architect: Sasaki/Newman Architects
Facade Consultant: Cladding Concepts International
Facade Installer: Acranom Masonry
Cladding System: Strongfix
Image: Tim Gormley

Neolith Jura
6+ MM - 1/4"

CUSTOM MADE
COLOR

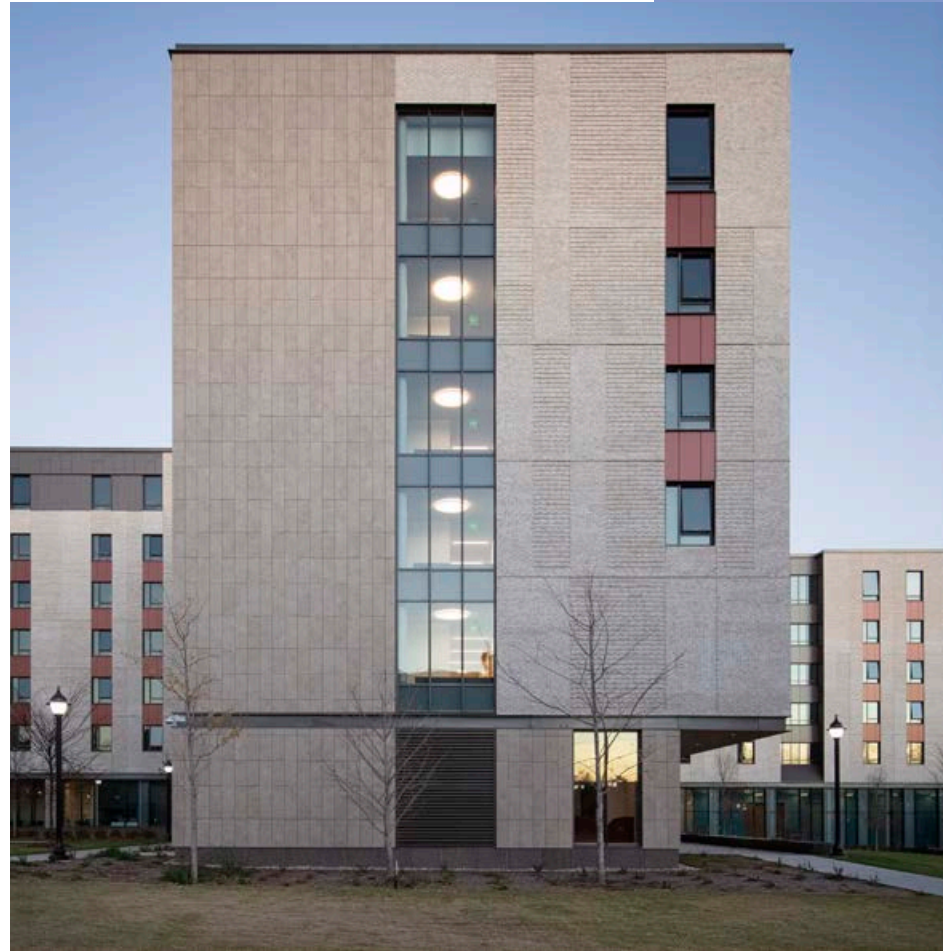

UConn DORMITORY,
Storrs, CT (USA)

Architect: Sasaki/Newman Architects
Facade Consultant: Cladding Concepts International
Facade Installer: Acranom Masonry
Cladding System: Strongfix
Image: Tim Gormley



SOL MARINA
Gdansk, (Poland)

Contractor: Dekpol Construction
Image: Patryk Kośmider





PRIVATE RESIDENCE
Vitoria, (Spain)

Ventilated facade: Cement and Basalt Black
Design: Unai - Arimaleku Estudio
Image: Neolith Branding Team





PRIVATE RESIDENCE,
Almeria, (Spain)

Design: Gregorio Morete
Image: Neolith Branding Team

Pietra Di Piombo Silk

FUSION

Nero Satin

COLORFEEL

6+ MM - 1/4"

PRIVATE RESIDENCE,
Camargo - Cantabria, (Spain)

Cut-to-size
Design: Agustin Montes
Cladding System: HC System
Image: Ainhoa Anaut



Arena Satin
& Krater Riverwashed
6 MM - 1/4"

FUSION



PRIVATE RESIDENCE,
Madrid, (Spain)

Design: Garriguez Asociados Arquitectos
Image: Neolith Branding Team

Iron Corten | IRON
6 MM - 1/4"

MOSSA ÖZLÜCE ROOMS,
Bursa, (Turkey)

Ventilated faade: Iron Corten
Design: Iřıl Genođlu-Süleyman Tařar
Image: Burak Teoman





PRIVATE RESIDENCE,
Barcelona, (Spain)

Design: bAR Arquitectura i Disseny
Image: Rafael Vargas

Just White Silk
Basalt Black Satin
6 MM - 1/4"

COLORFEEL
FUSION



VILLA LUCILLE,
Istanbul, (Turkey)

Cladding System: HC System
Design: Kenan Deniz and
TEAM Proje Architecture team



Just White Silk
Cement Satin
6 MM - 1/4"

COLORFEEL
FUSION



FAMILY HOUSING UNIÓN,
Madrid, (Spain)

Cut-to-size
Design: Marta Gonzalez Arquitectos
Cladding System: HC System
Installation: Euroclad
Image: Isabel Orbe Retana

Iron Frost Silk
Basalt Grey Silk
6 MM - 1/4"

IRON
FUSION



PRIVATE RESIDENCE,
New York, (USA)

Cut To Size
Cladding System: HC System
Design: Michael Shilale Architects, LLP
Facade Consultant: Cladding Concepts
International

Nero Zimbabwe
Riverwashed
6 MM - 1/4"

FUSION



TECHSIZE BY NEOLITH
Hangzhou, (China)

Phedra, Basalt Black
& Basalt Grey
6 MM - 1/4"

FUSION



ZIEKENHUIS OOST-LIMBURG HOSPITAL
Genk, (Belgium)

Cladding System: StrongFix
Design: Architectengroep A4
Image: Neolith Branding Team

Basalt Grey
6 MM - 1/4"

FUSION



NAVY FEDERAL CREDIT UNION
Winchester, (USA)

Ventilated facade: Basalt Grey
Design: MGMA Design
Image: Neolith Branding Team



ABN AMRO BUILDING,
Utrecht, (Netherlands)

Ventilated facade: Strata Argentum Riverwashed
Design: Bakers Architecten BV



Basalt Grey | FUSION
6 MM - 1/4"



SUNTRUST BANK
Nashville, (USA)

Cladding System: Cerमितex
Design: Gensler
Image: Neolith Branding Team

Strata Argentum Riverwashed
6 MM - 1/4"

THE NEW
CLASSTONE



LA RESERVA RESIDENCE
Medellín, (Colombia)

Stonemason: Volterra Stone
Distributed: VIANOVA SAS
Image: Mateo Soto

Pietra di Osso Silk | FUSION
Pietra di Luna Silk
6+ MM - 1/4"

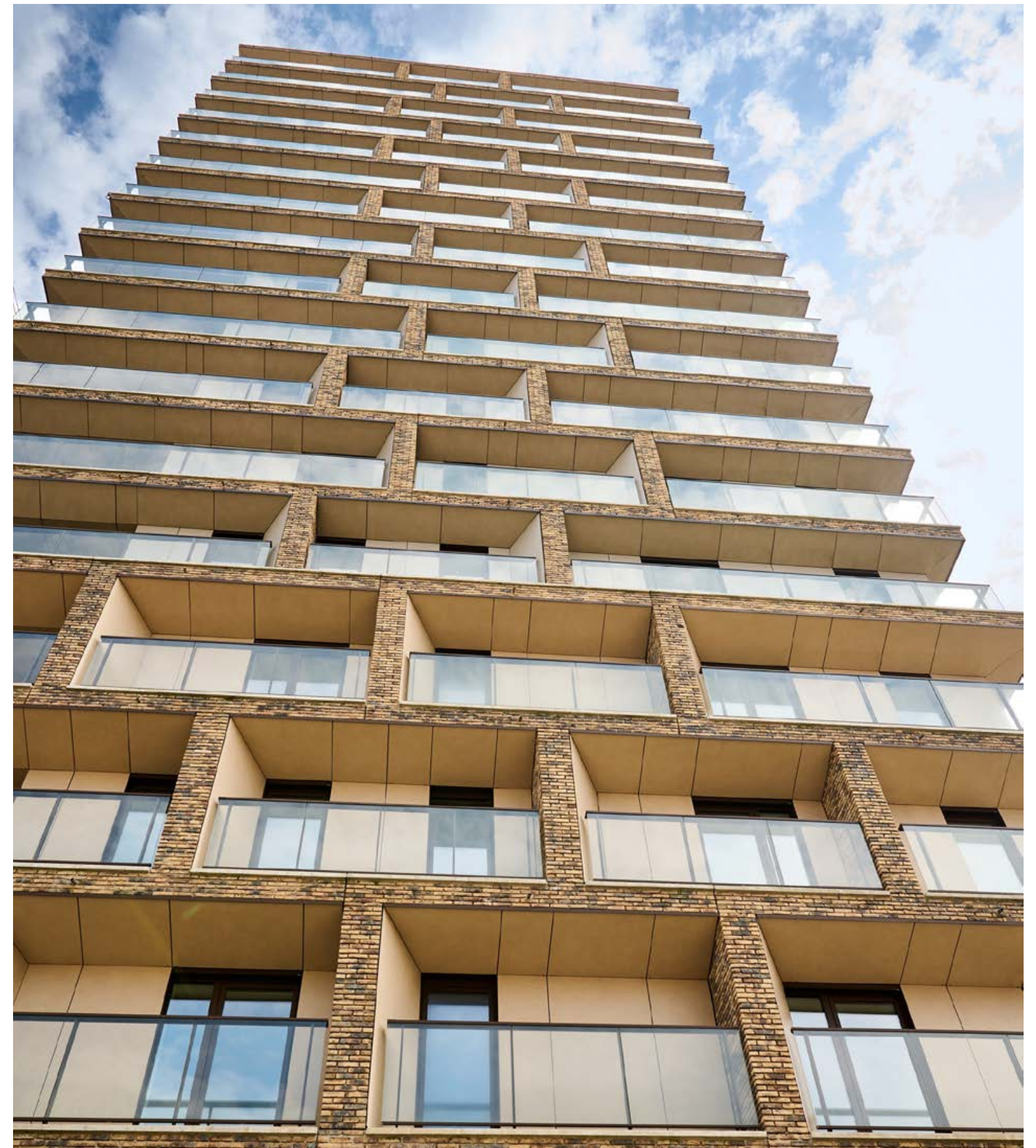

PROJECTS

O'SEA
Oostende, (Belgium)

Cladding System: VM System
Design: Inmobel Group
Image: O'SEA Beach

NEOLITH GALLERY

The Neolith collection features 58 unique models, categorized into 6 distinct collections. Many of these models are available in multiple finishes and thicknesses, providing versatility for various applications. Additionally, select models offer Bookmatch and Endmatch options.

La colección de Neolith se compone de 58 modelos agrupados en 6 colecciones. La gran mayoría de esos modelos están disponibles en más de un acabado y espesor distinto e incluso algunos de ellos disponen de opciones Bookmatch o Endmatch.

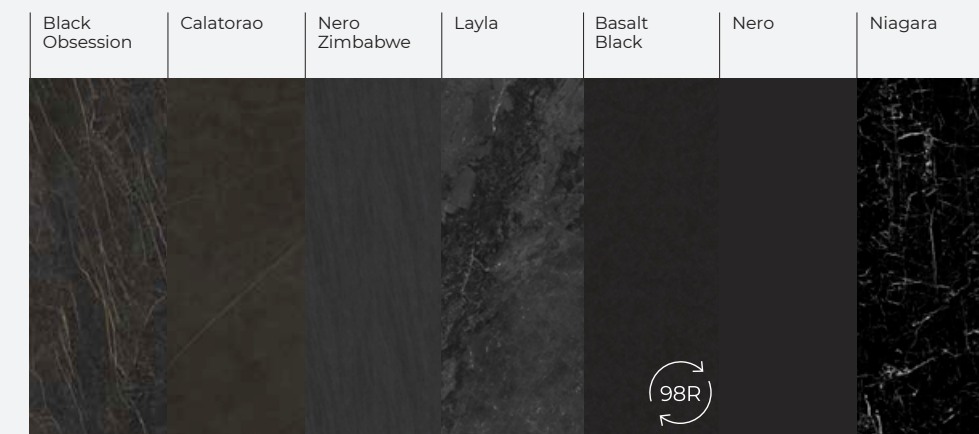
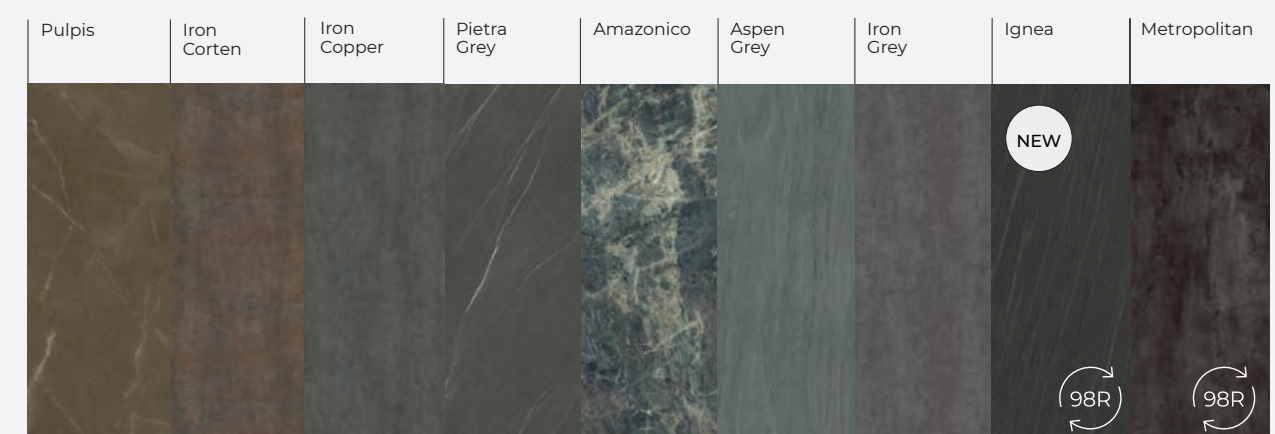
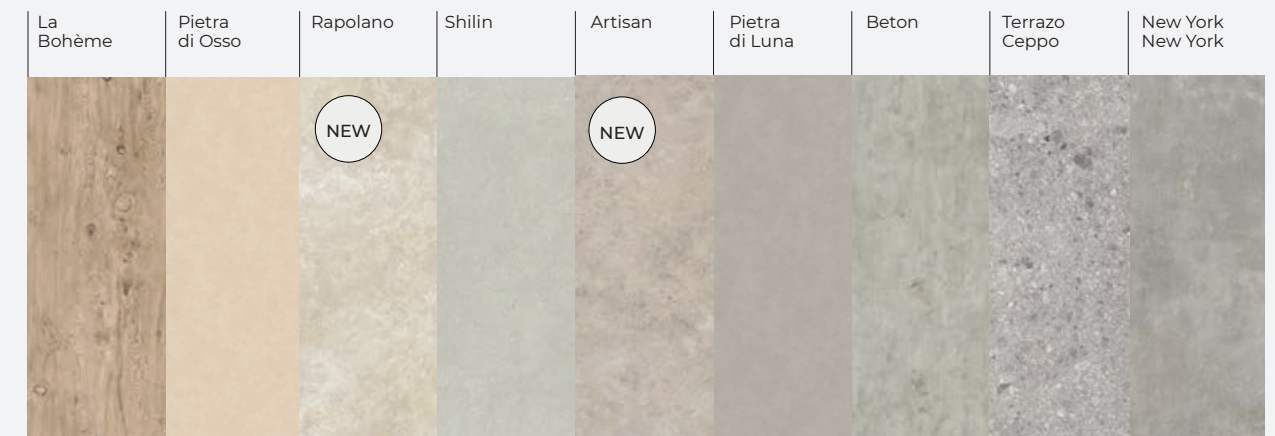
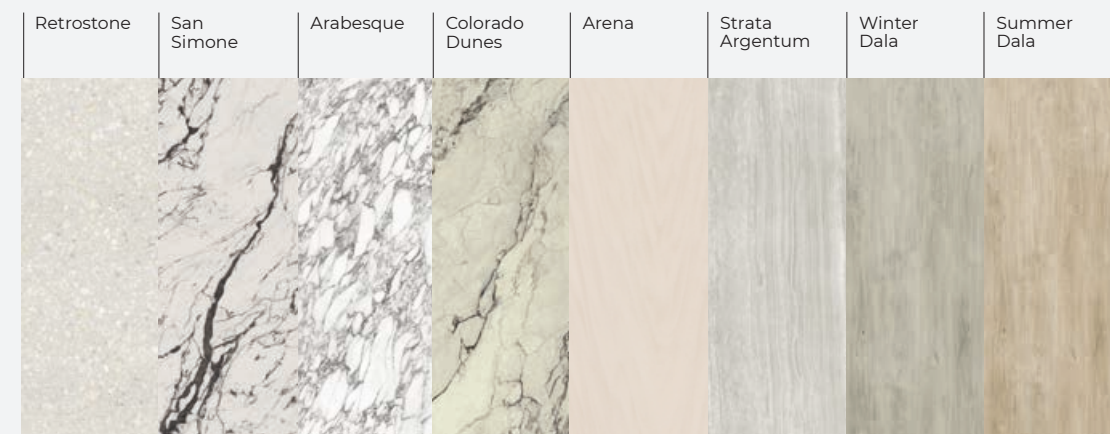
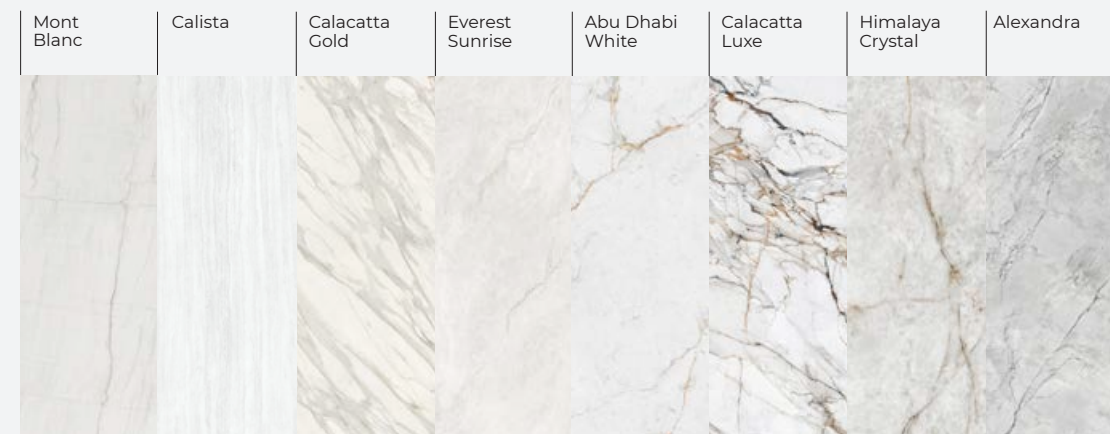
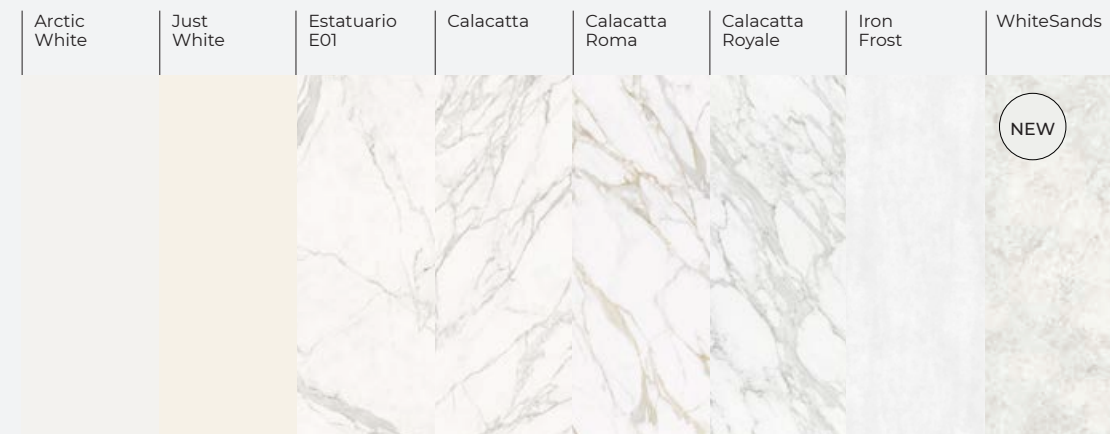

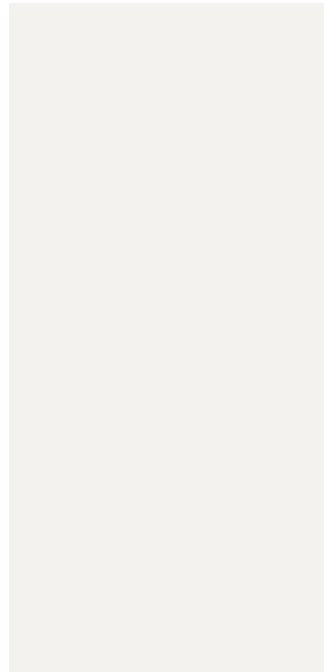

Arctic White

	mm	Satin	Silk	Pol.	U. Soft	Riv. Slate
3.600 x 1.200	3	•	•			
3.200 x 1.500	6	•	•			
3.200 x 1.600	12	•	•			
	20					

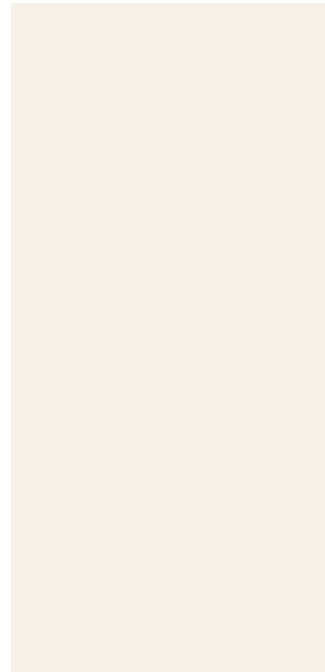

Just White

	mm	Satin	Silk	Pol.	U. Soft	Riv. Slate
3.600 x 1.200	3		•			
3.200 x 1.500	6		•			
3.200 x 1.600	12		•			
	20		•			



Estatuario E01

	mm	Satin	Silk	Pol.	U. Soft	Riv. Slate
3.600 x 1.200	3		•			
3.200 x 1.500	6		•	•	•	
3.200 x 1.600	12		•	•	•	
	20		•	•	•	



Calacatta

	mm	Satin	Silk	Pol.	U. Soft	Riv. Slate
3.600 x 1.200	3		•			
3.200 x 1.500	6		•	•	•	
3.200 x 1.600	12		•	•	•	
	20		•	•	•	

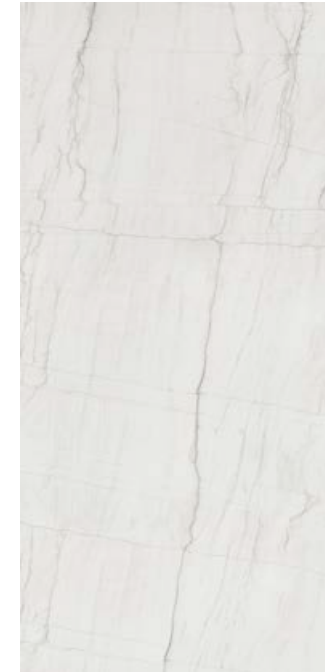

Mont Blanc

	mm	Satin	Silk	Pol.	U. Soft	Riv. Slate
3.600 x 1.200	3		•			
3.200 x 1.500	6		•			
3.200 x 1.600	12		•			
	20		•			



Calista

	mm	Satin	Silk	Pol.	U. Soft	Riv. Slate
3.600 x 1.200	3				•	•
3.200 x 1.500	6				•	•
3.200 x 1.600	12				•	•
	20				•	•



Calacatta Gold

	mm	Satin	Silk	Pol.	U. Soft	Riv. Slate
3.600 x 1.200	3		•			
3.200 x 1.500	6		•	•	•	
3.200 x 1.600	12		•	•	•	
	20		•	•	•	



Everest Sunrise

	mm	Satin	Silk	Pol.	U. Soft	Riv. Slate
3.600 x 1.200	3					
3.200 x 1.500	6		•	•	•	
3.200 x 1.600	12		•	•	•	
	20		•	•	•	



Calacatta Roma

	mm	Satin	Silk	Pol.	U. Soft	Riv. Slate
3.600 x 1.200	3					
3.200 x 1.500	6		•			
3.200 x 1.600	12		•			
	20		•			



Calacatta Royale

	mm	Satin	Silk	Pol.	U. Soft	Riv. Slate
3.600 x 1.200	3					
3.200 x 1.500	6		•	•	•	
3.200 x 1.600	12		•	•	•	
	20		•	•	•	



Iron Frost

	mm	Satin	Silk	Pol.	U. Soft	Riv. Slate
3.600 x 1.200	3					
3.200 x 1.500	6		•			
3.200 x 1.600	12		•			
	20		•			

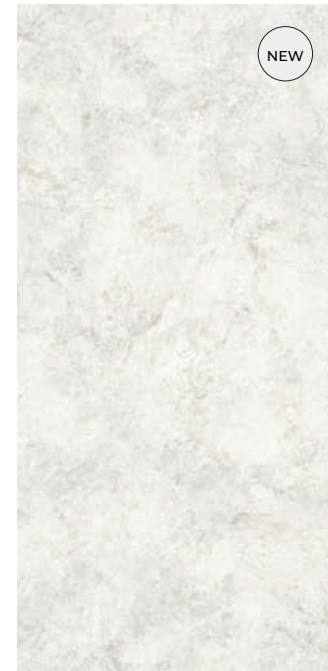

WhiteSands

	mm	Satin	Silk	Natural Touch	Slate
3.600 x 1.200	3				
3.200 x 1.500	6				•
3.200 x 1.600	12			•	
	20			•	

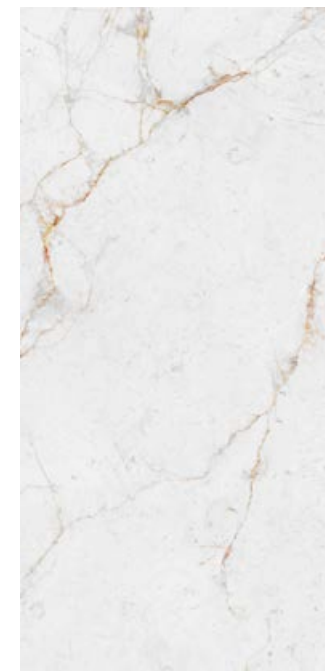

Abu Dhabi White

	mm	Satin	Silk	Pol.	U. Soft	Riv. Slate
3.600 x 1.200	3		•			
3.200 x 1.500	6		•	•		
3.200 x 1.600	12		•	•		
	20		•	•		



Calacatta Luxe

	mm	Satin	Silk	Pol.	U. Soft	Riv. Slate
3.600 x 1.200	3				•	•
3.200 x 1.500	6				•	•
3.200 x 1.600	12				•	•
	20				•	•

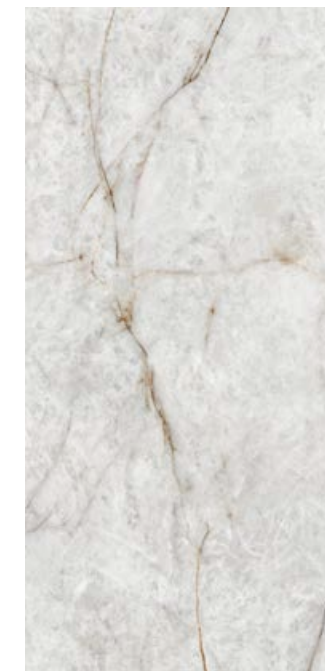

Himalaya Crystal

	mm	Satin	Silk	Pol.	U. Soft	Riv. Slate
3.600 x 1.200	3					
3.200 x 1.500	6		•	•	•	
3.200 x 1.600	12		•	•	•	
	20		•	•	•	



Alexandra

	mm	Satin	Silk	Pol.	U. Soft	Riv. Slate
3.600 x 1.200	3					
3.200 x 1.500	6		•	•	•	
3.200 x 1.600	12		•	•	•	
	20		•	•	•	



Retrostone

	mm	Satin	Silk	Pol.	U. Soft	Riv. Slate
3.600 x 1.200	3					
3.200 x 1.500	6		•			
	12		•			
3.200 x 1.600	20		•			



San Simone

	mm	Satin	Silk	Pol.	U. Soft	Riv. Slate
3.600 x 1.200	3					
3.200 x 1.500	6		•	•	•	
	12		•	•	•	
3.200 x 1.600	20		•	•	•	



Arabesque

	mm	Satin	Silk	Pol.	U. Soft	Riv. Slate
3.600 x 1.200	3					
3.200 x 1.500	6		•			
	12		•			
3.200 x 1.600	20		•			

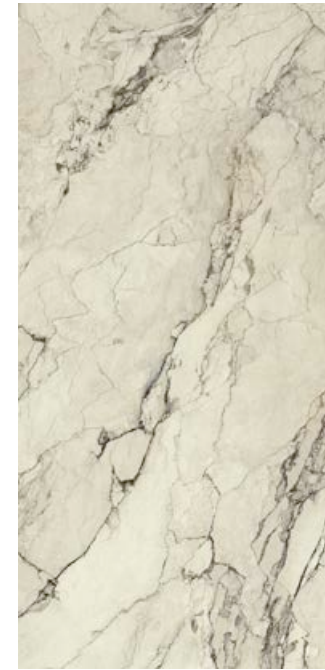

Colorado Dunes

	mm	Satin	Silk	Pol.	U. Soft	Riv. Slate
3.600 x 1.200	3					
3.200 x 1.500	6		•	•	•	
	12		•	•	•	
3.200 x 1.600	20		•	•	•	



La Bohème

	mm	Satin	Silk	Pol.	U. Soft	Riv. Slate
3.600 x 1.200	3					
3.200 x 1.500	6	•				
	12	•				
3.200 x 1.600	20	•				



Pietra di Osso

	mm	Satin	Silk	Pol.	U. Soft	Riv. Slate
3.600 x 1.200	3		•			
3.200 x 1.500	6		•			
	12		•			
3.200 x 1.600	20		•			



Rapolano

	mm	Satin	Silk	Natural Touch	Slate
3.600 x 1.200	3				
3.200 x 1.500	6				•
	12			•	
3.200 x 1.600	20			•	



Shilin

	mm	Satin	Silk	Pol.	U. Soft	Riv. Slate
3.600 x 1.200	3					
3.200 x 1.500	6					•
	12					•
3.200 x 1.600	20					•

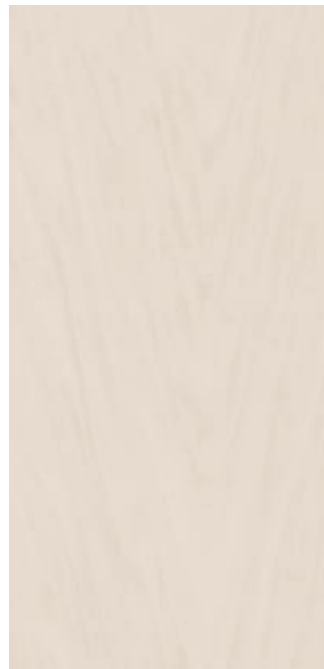

Arena

	mm	Satin	Silk	Pol.	U. Soft	Riv. Slate
3.600 x 1.200	3	•				
3.200 x 1.500	6	•				
	12	•				
3.200 x 1.600	20					



Strata Argentum

	mm	Satin	Silk	Pol.	U. Soft	Riv. Slate
3.600 x 1.200	3					•
3.200 x 1.500	6					•
	12					•
3.200 x 1.600	20					•



Winter Dala

	mm	Satin	Silk	Pol.	U. Soft	Riv. Slate
3.600 x 1.200	3					
3.200 x 1.500	6		•			
	12		•			
3.200 x 1.600	20		•			



Summer Dala

	mm	Satin	Silk	Pol.	U. Soft	Riv. Slate
3.600 x 1.200	3					
3.200 x 1.500	6		•			
	12		•			
3.200 x 1.600	20		•			



Artisan

	mm	Satin	Silk	Pol.	U. Soft	Riv. Slate
3.600 x 1.200	3					
3.200 x 1.500	6		•			
	12		•			
3.200 x 1.600	20		•			



Pietra di Luna

	mm	Satin	Silk	Pol.	U. Soft	Riv. Slate
3.600 x 1.200	3		•			
3.200 x 1.500	6		•			
	12		•			
3.200 x 1.600	20		•			

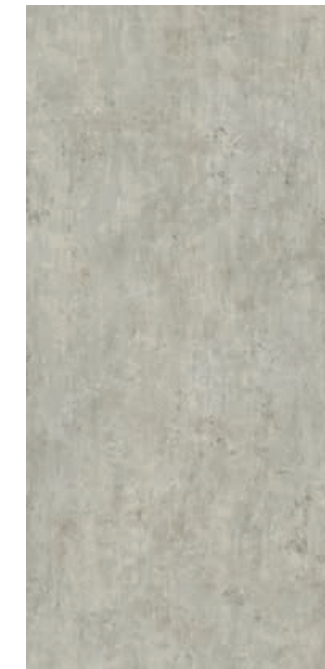

Beton

	mm	Satin	Silk	Pol.	U. Soft	Riv. Slate
3.600 x 1.200	3					
3.200 x 1.500	6		•			
	12		•			
3.200 x 1.600	20		•			

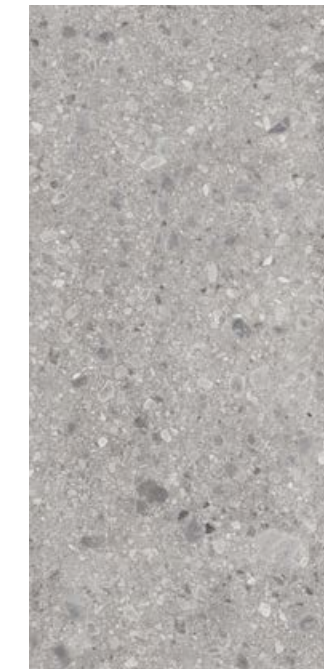

Terrazo Ceppo

	mm	Satin	Silk	Pol.	U. Soft	Riv. Slate
3.600 x 1.200	3					
3.200 x 1.500	6		•			
	12		•			
3.200 x 1.600	20		•			



New York New York

	mm	Satin	Silk	Pol.	U. Soft	Riv. Slate
3.600 x 1.200	3		•			
3.200 x 1.500	6		•			
3.200 x 1.600	12		•			
	20		•			

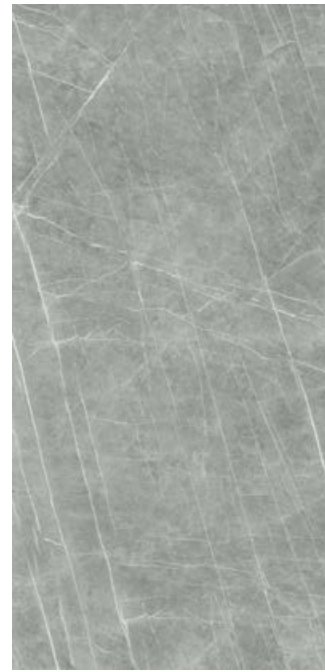

Zaha Stone

	mm	Satin	Silk	Pol.	U. Soft	Riv. Slate
3.600 x 1.200	3		•			
3.200 x 1.500	6		•			
3.200 x 1.600	12		•			
	20		•			

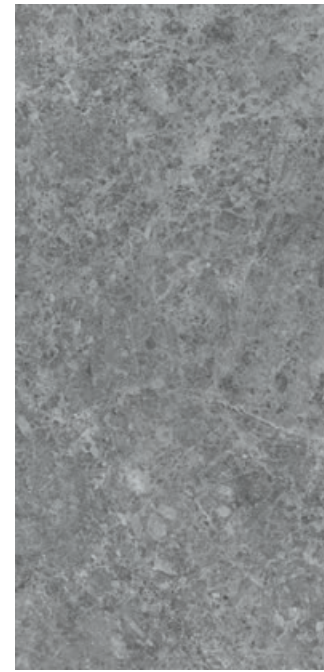

Cappadocia Sunset

	mm	Satin	Silk	Pol.	U. Soft	Riv. Slate
3.600 x 1.200	3		•			
3.200 x 1.500	6		•			
3.200 x 1.600	12		•			
	20		•			



Phedra

	mm	Satin	Silk	Pol.	U. Soft	Riv. Slate
3.600 x 1.200	3		•			
3.200 x 1.500	6		•			
3.200 x 1.600	12		•			
	20		•			



Basalt Grey

	mm	Satin	Silk	Pol.	U. Soft	Riv. Slate
3.600 x 1.200	3					
3.200 x 1.500	6	•				
3.200 x 1.600	12	•				
	20					



Barro

	mm	Satin	Silk	Pol.	U. Soft	Riv. Slate
3.600 x 1.200	3					
3.200 x 1.500	6	•				
3.200 x 1.600	12	•				
	20					



Pulpis

	mm	Satin	Silk	Pol.	U. Soft	Riv. Slate
3.600 x 1.200	3		•			
3.200 x 1.500	6		•			
3.200 x 1.600	12		•			
	20		•			



Iron Corten

	mm	Satin	Silk	Pol.	U. Soft	Riv. Slate
3.600 x 1.200	3		•			
3.200 x 1.500	6		•			
3.200 x 1.600	12		•			
	20		•			



Wulong

	mm	Satin	Silk	Pol.	U. Soft	Riv. Slate
3.600 x 1.200	3					
3.200 x 1.500	6					•
3.200 x 1.600	12					•
	20					•



Pietra di Piombo

	mm	Satin	Silk	Pol.	U. Soft	Riv. Slate
3.600 x 1.200	3		•			
3.200 x 1.500	6		•			
3.200 x 1.600	12		•			
	20		•			



Cement

	mm	Satin	Silk	Pol.	U. Soft	Riv. Slate
3.600 x 1.200	3					
3.200 x 1.500	6		•			
3.200 x 1.600	12		•			
	20		•			

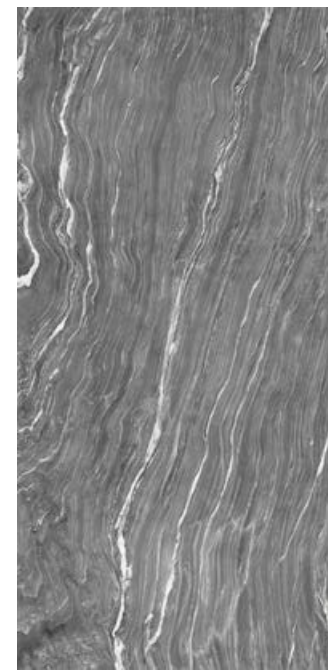

Mar del Plata

	mm	Satin	Silk	Pol.	U. Soft	Riv. Slate
3.600 x 1.200	3					
3.200 x 1.500	6					•
3.200 x 1.600	12					•
	20					•



Iron Copper

	mm	Satin	Silk	Pol.	U. Soft	Riv. Slate
3.600 x 1.200	3	•				
3.200 x 1.500	6	•				
3.200 x 1.600	12	•				
	20					

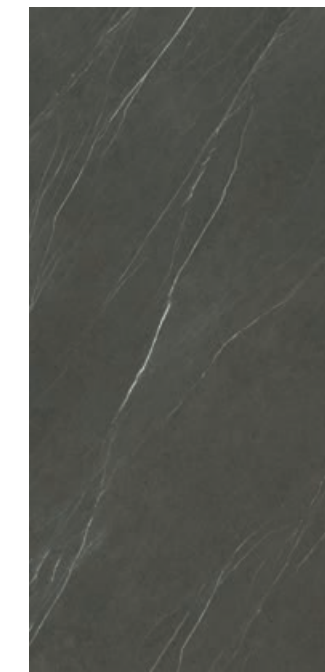

Pietra Grey

	mm	Satin	Silk	Pol.	U. Soft	Riv. Slate
3.600 x 1.200	3					
3.200 x 1.500	6		•			
3.200 x 1.600	12		•			
	20		•			

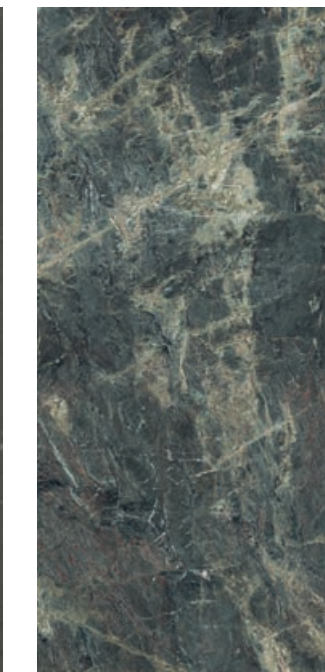

Amazonico

	mm	Satin	Silk	Pol.	U. Soft	Riv. Slate
3.600 x 1.200	3					
3.200 x 1.500	6			•		•
3.200 x 1.600	12					•
	20					•

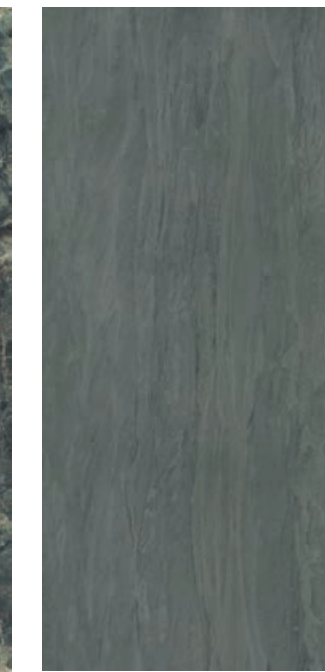

Aspen Grey

	mm	Satin	Silk	Pol.	U. Soft	Riv. Slate
3.600 x 1.200	3		•			
3.200 x 1.500	6		•			
3.200 x 1.600	12		•			
	20		•			



Iron Grey

	mm	Satin	Silk	Pol.	U. Soft	Riv. Slate
3.600 x 1.200	3	•				
3.200 x 1.500	6	•				
3.200 x 1.600	12	•				
	20	•				



Ignea

	mm	Satin	Silk	Pol.	U. Soft	Riv. Slate
3.600 x 1.200	3					
3.200 x 1.500	6					•
3.200 x 1.600	12					•
	20					•



Metropolitan

	mm	Satin	Silk	Pol.	U. Soft	Steel Touch
3.600 x 1.200	3					
3.200 x 1.500	6					•
3.200 x 1.600	12					•
	20					•



Nero Zimbabwe

	mm	Satin	Silk	Pol.	U. Soft	Riv. Slate
3.600 x 1.200	3					•
3.200 x 1.500	6					•
3.200 x 1.600	12					•
	20					•

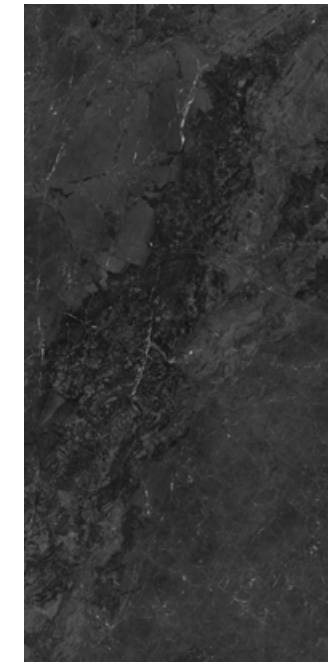

Layla

	mm	Satin	Silk	Pol.	U. Soft	Riv. Slate
3.600 x 1.200	3					
3.200 x 1.500	6			•		•
3.200 x 1.600	12			•		•
	20			•		•

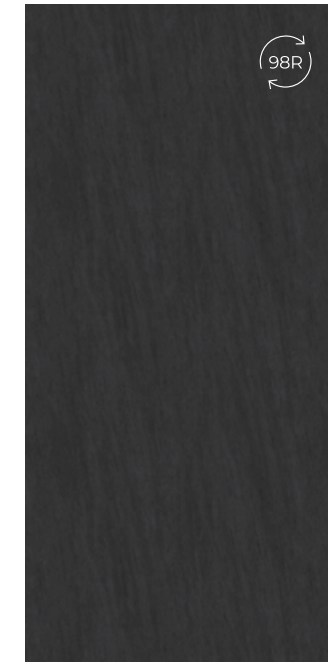

Basalt Black

	mm	Satin	Silk	Pol.	U. Soft	Riv. Slate
3.600 x 1.200	3	•				
3.200 x 1.500	6	•				
3.200 x 1.600	12	•				
	20	•				



Black Obsession

	mm	Satin	Silk	Pol.	U. Soft	Riv. Slate
3.600 x 1.200	3					
3.200 x 1.500	6		•			
3.200 x 1.600	12		•			
	20		•			

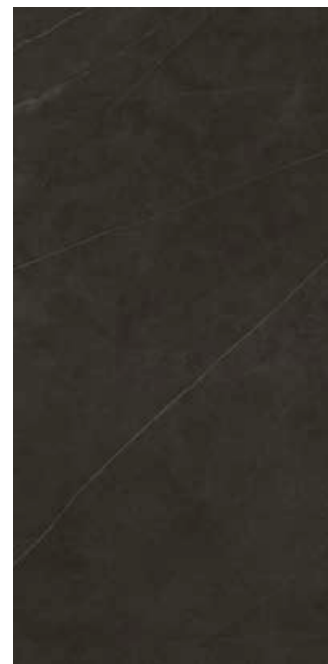

Calatorao

	mm	Satin	Silk	Pol.	U. Soft	Riv. Slate
3.600 x 1.200	3		•			
3.200 x 1.500	6		•			
3.200 x 1.600	12		•			
	20		•			



Nero

	mm	Satin	Silk	Pol.	U. Soft	Riv. Slate
3.600 x 1.200	3	•				
3.200 x 1.500	6	•				
3.200 x 1.600	12	•				
	20	•				

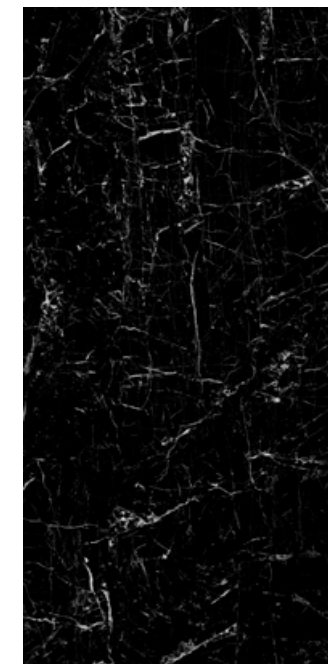

Niagara

	mm	Satin	Silk	Pol.	U. Soft	Riv. Slate
3.600 x 1.200	3					
3.200 x 1.500	6		•	•		
3.200 x 1.600	12		•	•		
	20		•	•		

Models only available for projects Modelos solo disponibles para proyectos

Starting from 4,000 m² (43,000 sqft) for 3 and 6 mm, 3,000 m² (32,300 sqft) for 12 mm and 2,000 m² (21,500 sqft) for 20 mm of thickness, Neolith has several different models available to choose from for large-scale projects.

Consult your local distributor or email projects@neolith.com for more information.

A partir de 4.000 m² para 3 y 6 mm y 3.000 m² para 12 mm y 2.000 m² para 20 mm de espesor, Neolith tiene disponibles una serie de modelos distintos para elegir para grandes proyectos.

Consulta a tu distribuidor o envía un email a projects@neolith.com para más información.



Design variants in Variantes de diseño 6 mm - 1/4"

To avoid repeating design in some Neolith models, variants have been created and will be **shipped randomly** when ordering these models, without the possibility of choosing the design.
Only available in 6 mm - 1/4" thickness.

Para evitar la repetición de diseño en algunos modelos Neolith, se han creado variantes que se **enviarán de forma aleatoria**, en los pedidos de estos colores, sin la posibilidad de elegir el diseño.
Disponible solo en 6 mm de espesor.

WhiteSands



Mont Blanc

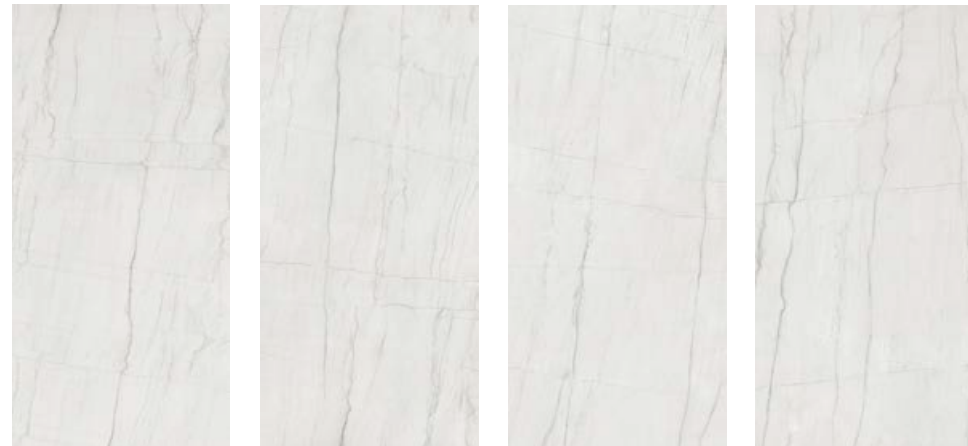

Everest Sunrise



Abu Dhabi White

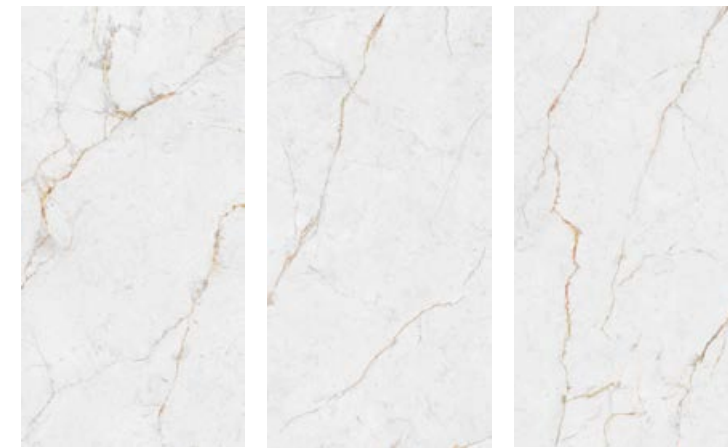

Himalaya Crystal



Retrostone



Strata Argentum



Design variants in / Variantes de diseño 6 mm - 1/4"

Winter Dala



Summer Dala



Rapolano



Shilin



Artisan



Beton



New York- New York



Zaha Stone

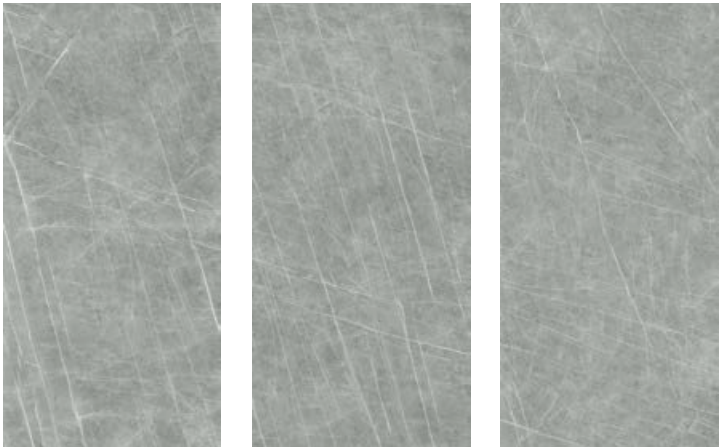

Design variants in / Variantes de diseño 6 mm - 1/4"

Cappadocia
Sunset

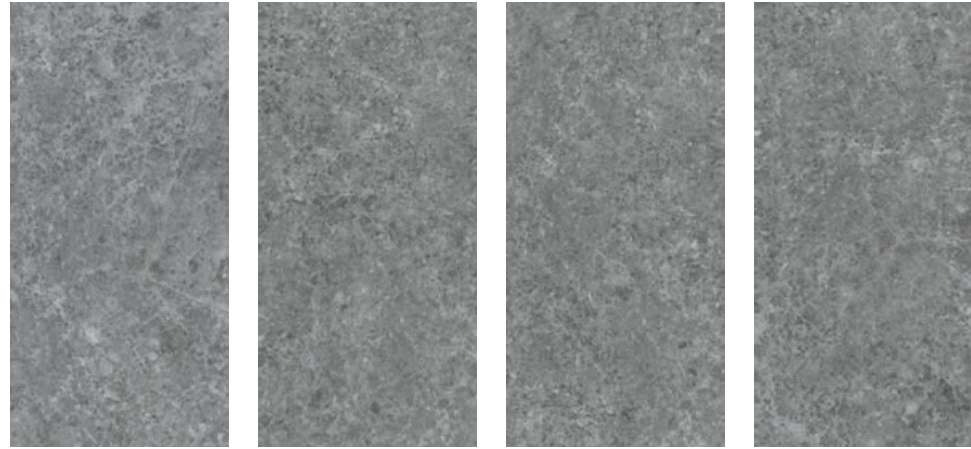

Wulong



Mar Del Plata

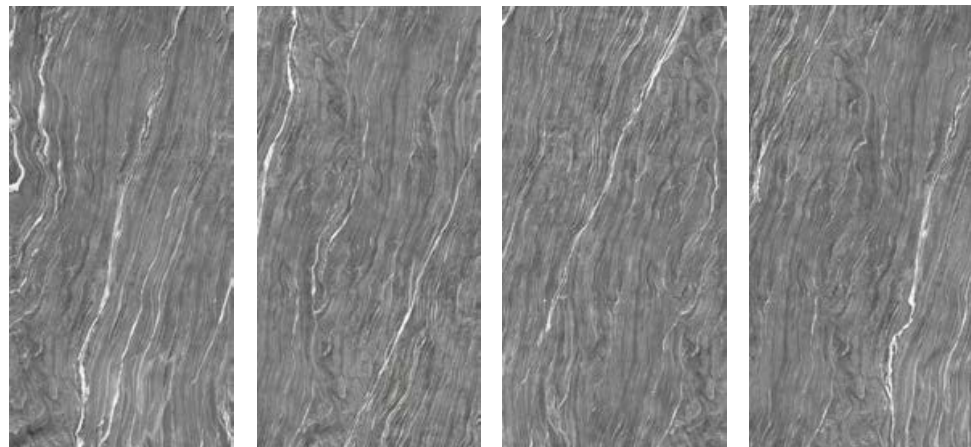

Amazonico

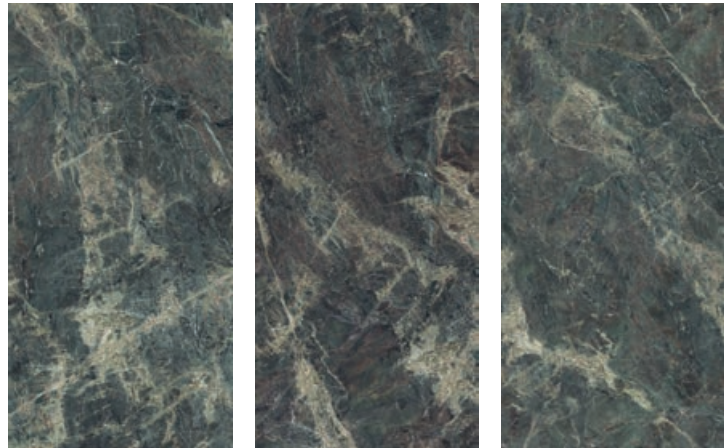

Aspen Grey



Ignea



Metropolitan



Calatorao



Layla

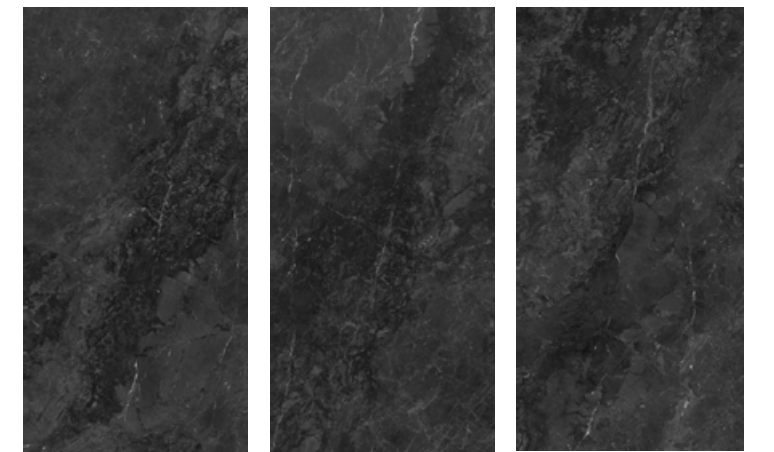



Bookmatch & Endmatch

Some Neolith models can come with a Bookmatched effect (mirror effect), just as when natural marble is extracted directly from a quarry. There is a Reverse option (marked with an "R") for each color in order to create Bookmatched options.

The Endmatch is a very special feature used in some New Classtone models. Using the same slab and just turning it 180°, it's possible to obtain continuing vein with an endless pattern.

Algunos modelos Neolith permiten la posibilidad de presentarse con efecto Bookmatch (efecto espejo) de la misma forma que el mármol natural es directamente extraído de una cantera. Para cada modelo se ha creado una versión inversa (marcada con "R") para presentar efectos Bookmatched.

El Endmatch es una característica muy especial que tienen algunos modelos en New Classtone Usando la misma tabla, sólo girándola 180°, puede obtenerse un patrón de vena continua sin fin.

Estatuario E01 Bookmatch

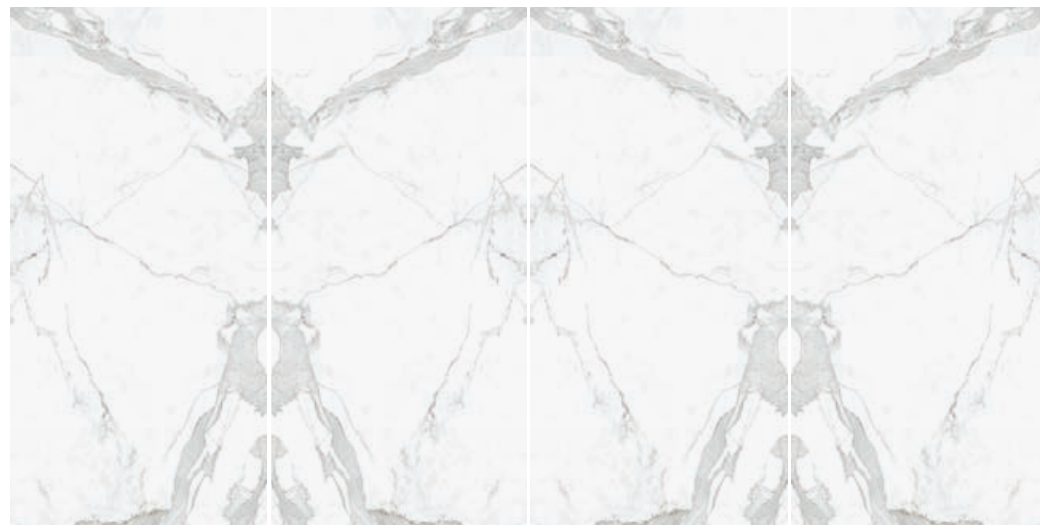

Estatuario E01

Estatuario E01R

Estatuario E01

Estatuario E01R

Calacatta Gold Endmatch

Calacatta Gold Bookmatch



Calacatta Gold CG01

Calacatta Gold CG01

Calacatta Gold CG01

Calacatta Gold CG01R

Calacatta Gold CG01



Calacatta Roma Endmatch

Calacatta Roma Bookmatch



Calacatta Roma CR01

Calacatta Roma CR01

Calacatta Roma CR01

Calacatta Roma CR01R

Calacatta Roma CR01



Calacatta Endmatch

Calacatta Bookmatch



Calacatta C01

Calacatta C01

Calacatta C01R

Calacatta C01

Calacatta C01R



Bookmatch

Calacatta Royale Bookmatch



Calacatta Royale CR01 Calacatta Royale CR01R Calacatta Royale CR01

Colorado Dunes Bookmatch



Colorado Dunes CD01R Colorado Dunes CD01 Colorado Dunes CD01R Colorado Dunes CD01

Calacatta Luxe Bookmatch



Calacatta Luxe CL01 Calacatta Luxe CL01R Calacatta Luxe CL01

San Simone Bookmatch



San Simone SM01R San Simone SM01 San Simone SM01R San Simone SM01

Arabesque Bookmatch



Arabesque AR01 Arabesque AR01R Arabesque AR01

Niagara Bookmatch

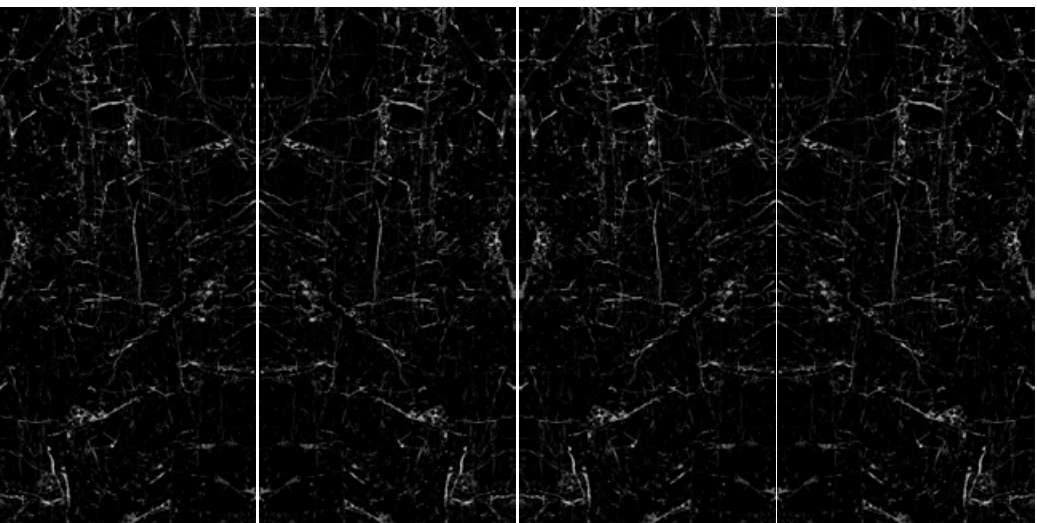

Niagara NG01 Niagara NG01R Niagara NG01 Niagara NG01R

General Summary Resumen General 2025

This table may be updated at any time.
Please check Neolith.com to get the latest version.

Esta tabla puede tener actualizaciones en cualquier momento.
Por favor consultar en Neolith.com para descargar la última versión.

OTHER FORMATS -
BUILD TO ORDER Delivery time,
please ask your commercial agent.
projects@neolith.com

Dimensions in inches are in nominal inches.

OTROS FORMATOS -
Plazo de entrega especial, consulte a su
agente comercial.

 New color / Color nuevo
Check availability with your local distributor. / Consulta la disponibilidad con tu distribuidor.











































































 Available Bookmatch / Disponible Bookmatch.

 Available Endmatch / Disponible Endmatch.

 98% recycled material / 98% material reciclado.

BOOKMATCH (R) MODELS -
BUILD TO ORDER Delivery time,
please ask your commercial agent.
projects@neolith.com

MODELOS BOOKMATCH (R) -
Plazo de entrega especial, consulte a su
agente comercial.

		3600x1200 mm 142" x 47"	3200x1500 mm 126" x 59"	3200x1600 mm 126" x 63"	
		3 mm - 1/8"	6 mm - 1/4"	12 - 1/2"	20 mm - 3/4"
COLORFEEL	Arctic White	Silk / Satin	Silk / Satin	Silk / Satin	Silk
	Just White	Silk	Silk	Silk	Silk
	Nero	Satin	Satin	Satin	Satin
FUSION	Arena	Satin	Satin	Satin	---
	Artisan 	---	Silk	Silk	Silk
	Aspen Grey	Silk	Silk	Silk	Silk
	Barro	---	Satin	Satin	Satin
	Basalt Black 	Satin	Satin	Satin	Satin
	Basalt Grey	---	Satin	Satin	---
	Beton	---	Silk	Silk	Silk
	Black Obsession	---	Silk	Silk	Silk
	Cappadocia Sunset	Silk	Silk	Silk	Silk
	Cement	---	Satin	Satin	---
	Ignea 	---	Riverwashed	Riverwashed	Riverwashed
	Mar del Plata	---	Slate	Slate	---
	Nero Zimbabwe	Riverwashed	Riverwashed	Riverwashed	Riverwashed
	New York-New York	Silk	Silk	Silk	Silk
	Phedra	Satin	Satin	Satin	---
	Pietra Grey	---	Silk	Silk	---
	Pietra di Luna	Silk	Silk	Silk	Silk
	Pietra di Osso	Silk	Silk	Silk	Silk
	Pietra di Piombo	Silk	Silk	Silk	Silk
	Rapolano 	---	Slate	Natural Touch	Natural Touch
Retrostone	---	Silk	Silk	Silk	
Shilin	---	Slate	Slate	Slate	
Terrazo Ceppo	---	Silk	Silk	---	
Wulong	---	Slate	Slate	Slate	
Zaha Stone	Silk	Silk	Silk	Silk	
IRON	Iron Copper	Satin	Satin	Satin	---
	Iron Corten	Satin	Satin	Satin	Satin
	Iron Frost	---	Satin	Satin	---
	Iron Grey	Satin	Satin	Satin	Satin
TIMBER	La Bohème	---	Satin	Satin	---
	Summer Dala	---	Silk	Silk	---
	Winter Dala	---	Silk	Silk	---
NEW CLASSTONE	Abu Dhabi White	Silk	Silk / Décor polished	Silk / Décor polished	Silk
	Alexandra	---	Silk / Décor polished / Ultrasoft	Silk / Décor polished / Ultrasoft	Silk / Décor polished / Ultrasoft
	Amazonico	---	Décor polished / Slate	Slate	---
	Arabesque	---	Silk 	Silk 	Silk 
	Calacatta 	Silk	Silk  / Décor polished  / Ultrasoft 	Silk  / Décor polished  / Ultrasoft 	Silk  / Décor polished  / Ultrasoft 
	Calacatta Gold 	Silk	Silk  / Décor polished  / Ultrasoft 	Silk  / Décor polished  / Ultrasoft 	---
	Calacatta Luxe	---	Décor polished  / Ultrasoft 	Décor polished  / Ultrasoft 	---
	Calacatta Roma 	---	Silk 	Silk 	Silk 
	Calacatta Royale	---	Silk  / Décor polished  / Ultrasoft 	Silk  / Décor polished  / Ultrasoft 	Silk  / Décor polished  / Ultrasoft 
	Calatorao	Silk	Silk	Silk	Silk
	Calista	---	Décor polished / Ultrasoft	Décor polished / Ultrasoft	Décor polished / Ultrasoft
	Colorado Dunes	---	Silk  / Décor polished  / Ultrasoft 	Silk  / Décor polished  / Ultrasoft 	Silk  / Décor polished  / Ultrasoft 
	Estuario	Silk	Silk  / Décor polished  / Ultrasoft 	Silk  / Décor polished  / Ultrasoft 	Silk 
	Everest Sunrise	---	Silk / Décor polished / Ultrasoft	Silk / Décor polished / Ultrasoft	Silk / Décor polished / Ultrasoft
	Himalaya Crystal	---	Silk / Décor polished / Ultrasoft	Silk / Décor polished / Ultrasoft	Silk / Décor polished / Ultrasoft
	Layla	---	Décor polished / Slate	Décor polished / Slate	Slate
	Mont Blanc	Silk	Silk	Silk	Silk
	Niagara	---	Silk  / Décor polished 	Silk  / Décor polished 	Silk  / Décor polished 
	Pulpis	Silk	Silk	Silk	---
San Simone	---	Silk  / Décor polished  / Ultrasoft 	Silk  / Décor polished  / Ultrasoft 	Silk  / Décor polished  / Ultrasoft 	
Strata Argentum	Riverwashed	Riverwashed	Riverwashed	---	
WhiteSands 	---	Slate	Natural Touch	Natural Touch	
STEEL	Metropolitan 	---	Steel Touch	Steel Touch	Steel Touch

Los colores y acabados mostrados en este catálogo son aproximados y pueden variar respecto al producto final. Bajo ninguna circunstancia deben ser utilizados como referencia definitiva para la selección de materiales. Recomendamos solicitar muestras físicas a través de la plataforma de pedidos para garantizar una elección adecuada del material.

The colours and finishes shown in this catalogue are approximate and may vary from the final product. Under no circumstances should they be used as a definitive reference for the selection of materials. We recommend requesting physical samples through the ordering platform to ensure an appropriate choice of material.

NEOLITH
touch.feel.live

P. I. Camí Fondo, Supoi 8, C/. dels Ibers, 31
12550 Almazora (Castellón) SPAIN
info@neolith.com | neolith.com
projects@neolith.com

RESPONSIBLE TEAM
Neolith Branding Team

DESIGN
Neolith Team

Paper made with fibers from responsibly
managed forests.

NEOLITH

touch.feel.live